

Results of Geomagnetic Observations Belsk, Hel, Hornsund, 2006

Jan REDA, Mariusz NESKA, Włodzimierz GLEGOLSKI, and Stanisław WÓJCIK

Institute of Geophysics, Polish Academy of Sciences
ul. Księcia Janusza 64, 01-452 Warszawa, Poland

1. INTRODUCTION

This publication contains basic information on geomagnetic observations carried out in 2006 in three Polish geophysical observatories: Belsk (BEL), Hel (HLP), and Hornsund (HRN). All these observatories belong to the Institute of Geophysics, Polish Academy of Sciences. Observatories Belsk and Hel are located on the territory of Poland, while Hornsund is in Spitsbergen archipelago, governed by Norway.

In 2006, like in the previous years, the Belsk, Hel and Hornsund observatories have kept a close collaboration with the world network of geomagnetic observatories INTERMAGNET. The Belsk Observatory joined INTERMAGNET in 1992, Hel in 1999, and Hornsund in 2002.

It is to be noted that the present publication is the first joint yearbook for all the three Polish observatories.

2. DESCRIPTION OF OBSERVATORIES

The location of observatories is shown in Fig. 1 and Table 1. The geomagnetic coordinates in Table 1 were calculated in relation to the geomagnetic pole located at 83.2°N , 118.3°W on the basis of model IGRF-10 from epoch 2005.

The methodology of geomagnetic observations in all the three observatories was very similar, based on the "Guide for Magnetic Measurements and Observatory Practice" (Jankowski and Sucksdorff 1996). The instruments were similar too. Absolute measurements were made with the use of DI-flux magnetometers and proton magnetometers. The magnetic field variations were measured with the use of PSM magnetometers equipped in Bobrov's quartz variometers. The spare sets are equipped in PSM magnetometers or LEMI flux-gate magnetometers.

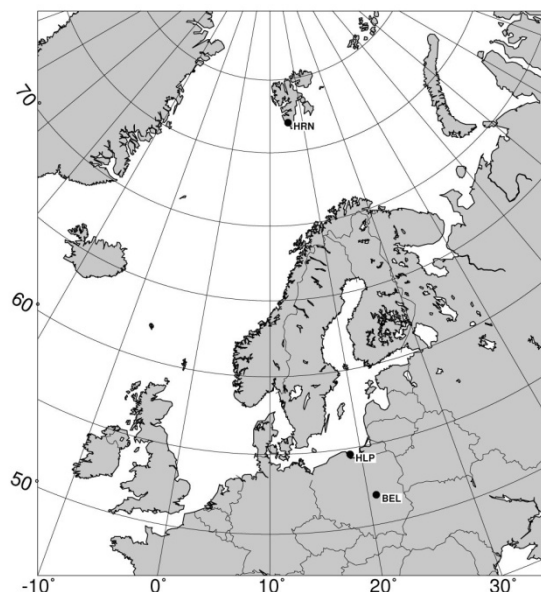

Fig. 1. Location of the Belsk, Hel and Hornsund observatories.

Table 1
Coordinates of the Polish Observatories

Observatory	Geographic coordinates		Geomagnetic coordinates		Elevation
	Latitude	Longitude	Latitude	Longitude	[m]
Belsk (BEL)	51°50.2' N	20°47.5' E	50.2°N	105.2° E	180
Hel (HLP)	54°36.5' N	18°49.0' E	53.2°N	104.6° E	1
Hornsund (HRN)	77°0.0' N	15°33.0' E	73.9°N	126.0° E	15

Continuous recording has been made by means of microprocessor-based digital loggers DR-02 or DR-03. Owing to the recording system we use and the fact that we strictly obey the procedures relating to the so-called magnetic service, the gaps in one-minute data from Belsk and Hel are practically absent. Short gaps have only occurred in records of the Hornsund station, because the conditions prevailing there are much harder than in Poland.

It is worth mentioning that in 2006 the Belsk and Hel Observatories have been continuing the permanent observation of the Shumann effect. Two horizontal components and the vertical component of the electric field have been recorded at a frequency of 100 Hz. This recording was initiated in both observatories in 2004 (Neska and Satori 2006).

2.1 Central Geophysical Observatory at Belsk, Central Poland

The Observatory at Belsk began continuous observations of the Earth magnetic field in 1965 (Jankowski and Marianiuk 2007). It continued the activity of the first Polish magnetic Observatory at Świder near Warsaw, working incessantly through the years 1920-1975. The magnetic observations were transferred from Świder to Belsk because of a strong increase of artificial noise from the Warsaw agglomeration, in particular due to the electric railroad passing nearby the Świder Observatory.

The Belsk Observatory is located at a distance of about 50 km south of Warsaw and about 2 km northwest of the village Belsk Duży. The premises of the Observatory, about 10 ha in area, is at the edge of the forest reserve Modrzewina, far away of people's settlements and automobile traffic. The location of the observatory in relation to the nearby towns and villages is shown in Fig. 2. The Observatory is surrounded by typically agricultural regions (with fertile soil, mostly apple orchards), so the direct neighborhood is deprived of sources of major artificial geomagnetic field disturbances. It is only the electric railroad (DC powered) situated some 14 km away of the Observatory to the north that produces some small artificial magnetic disturbances, whose average level usually does not exceed 1 nT.

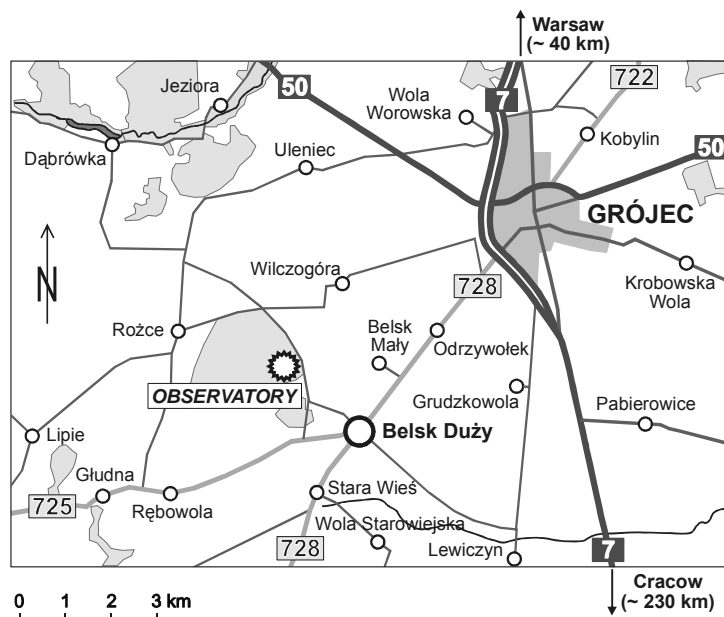

Fig. 2. Location of the Belsk Geophysical Observatory.

More information about the region in which the Observatory is located can be found, in English, Polish and German, on the internet pages of Grójec district (<http://www.grojec.pl>) to which the village Belsk Duży belongs. Relevant information can also be found at home pages of the Belsk Observatory and those of the Institute of Geophysics (<http://www.igf.edu.pl>).

2.2 Geophysical Observatory at Hel, Northern Poland

The Observatory at Hel began continuous observations of the earth magnetic field in 1932 (Jankowski and Marianiuk 2007). The observations were stopped in 1939, after the outbreak of World War II. During the war, the Observatory as well as its equipment and data were completely destroyed. After reconstruction, continuous observations at Hel were resumed in 1957.

The Hel Observatory is located in a small resort town at the end of Hel Peninsula by the Bay of Gdańsk (see Fig. 3). It is the area of Seaside Landscape Park (Nadmorski Park Krajobrazowy), weakly industrialized and urbanized. The region, surrounded by water from three sides, lacks any major artificial noise and is a good place for continuous magnetic observations.

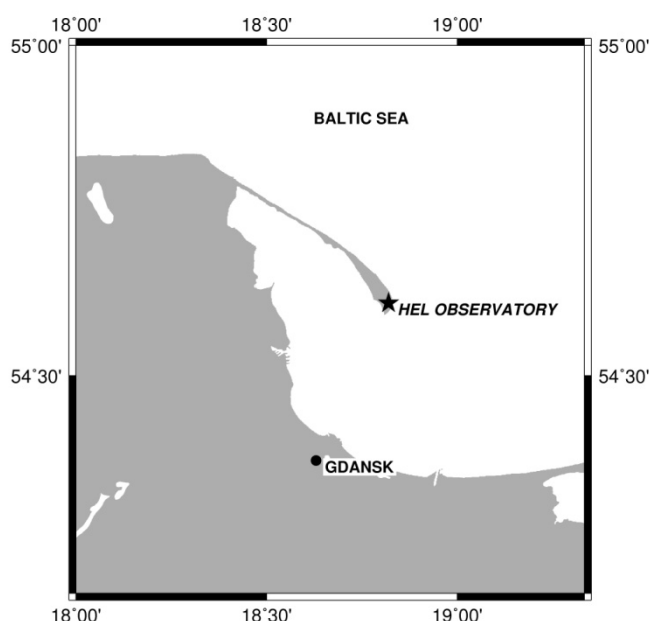

Fig. 3. Location of the Geophysical Observatory at Hel.

The observatory premises, about 4.5 ha in area, is surrounded by mixed forest (mainly pine and birch trees). Pavilions with measurement and recording instruments are located at small clearings.

More information about the town of Hel where the Observatory is located can be found at the address: <http://www.hel-miasto.pl/>.

2.3 Hornsund, Spitsbergen

The Polish Polar Station Hornsund is situated on the White Bear Bay (Isbjørnhamna) in Hornsund Fiord, Spitsbergen Island, Svalbard archipelago. (See Fig. 4). More information on the Svalbard Archipelago can be found at the address: <http://svalbard.com>

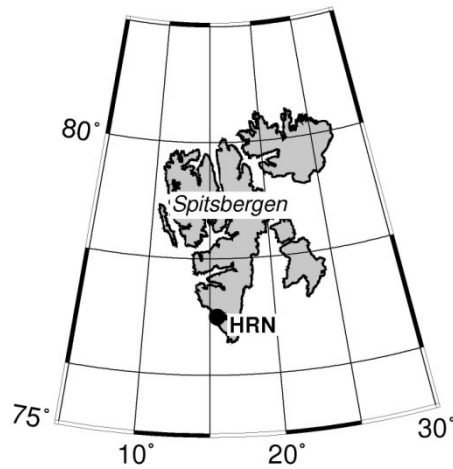

Fig. 4. Location of Polish Polar Station Hornsund.

The Hornsund station is the northernmost Polish scientific facility carrying out year-round activity. The Hornsund region is situated in a zone of strong magnetic field activity, much stronger than on the magnetic pole. Therefore, it is a very interesting place for magnetic observations.

Polish geomagnetic observations in the Arctic were initiated during the II Polar Year; a magnetic station was then established by S. Siedlecki and C. Centkiewicz on the Bear Island. In the years 1932/33, they had carried out continuous recording of magnetic field and performed absolute measurements. In the years 1957/58, in the framework of the III International Geophysical Year, measurements of magnetic declination and inclination were made by J. Kowalczyk and K. Karaczun in five sites in the Hornsund Fiord region.

Since the beginning of October 1978, continuous magnetic field recording has been put into operation, and systematic absolute measurements have been implemented (Jankowski and Marianiuk 2007). Since then, PSP Hornsund has begun to fulfill all the requirements for geomagnetic observatory.

Since 1993, PSP Hornsund has been participating in the IMAGE (International Monitor for Auroral Geomagnetic Effects) project. In the framework of this project, Hornsund data are being sent to a server in Finland, once a month on the average. Since 2002, PSP Hornsund is included into the global near-real-time magnetic observatory network INTERMAGNET, sending the results, via Internet, to the GIN (Geomagnetic Information Nodes) centers in Edinburgh and Paris.

3 INSTRUMENTATION

3.1 Introduction

Simplified block diagrams of geomagnetic observations in Belsk, Hel, and Hornsund Observatories are shown in Figs. 5, 6, and 7.

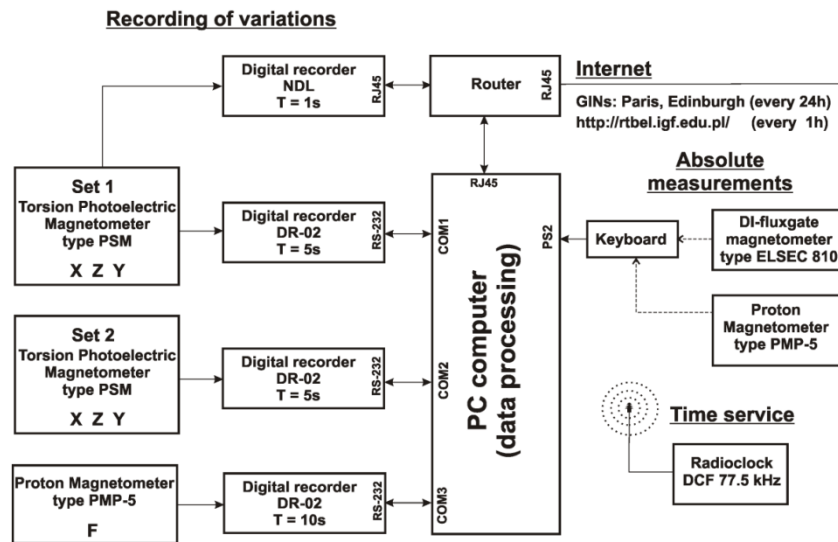

Fig. 5. Block diagram of magnetic observations system at Belsk

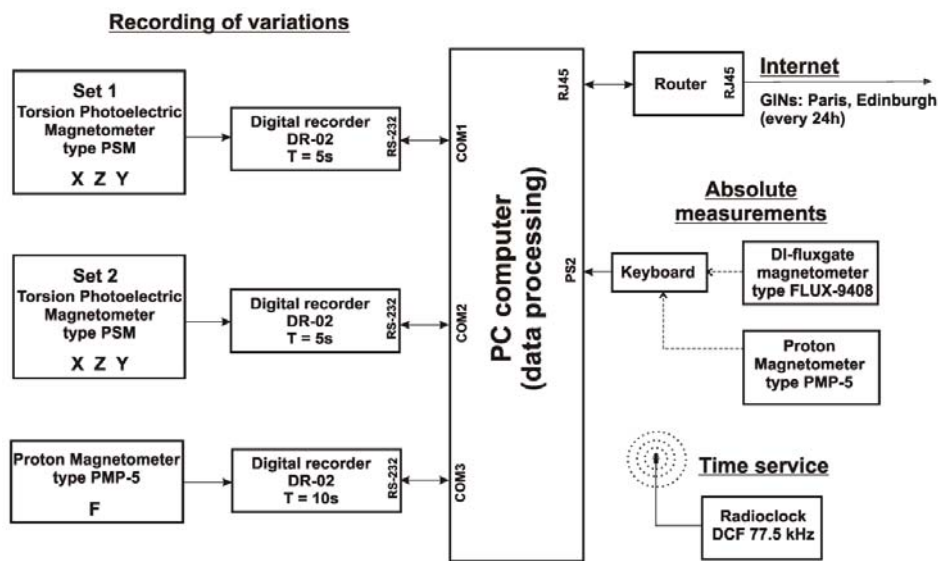

Fig. 6. Block diagram of magnetic observations system at Hel.

3.2 Absolute measurements

In all the three Polish observatories, the absolute measurements used for determination of bases of the recordings are performed by means of DI-flux and proton magnetometers. Di-flux magnetometers measure the absolute values of the angles of declination D and inclination I , while the proton magnetometers measure the absolute val-

ues of the total magnetic field vector F . From the measured values of F , D , and I , we can calculate all the remaining magnetic field components, H , X , Y , and Z .

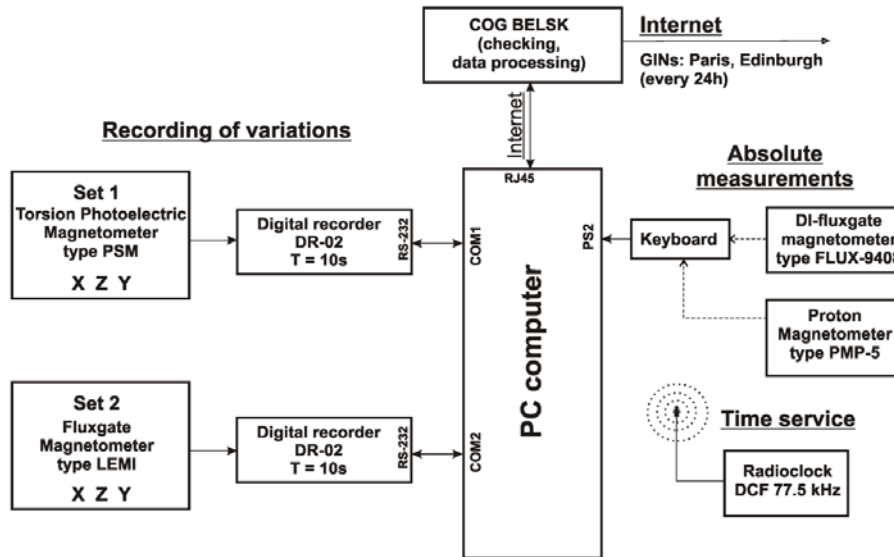

Fig. 7. Block diagram of the magnetic observations system at the Polish Polar Station Hornsund.

The instruments for absolute measurements are listed in Table 2, and the basic parameters of the instruments in Table 3.

Table 2
Instruments for absolute measurements

	Belsk	Hel	Hornsund
DI-fluxgate (fluxgate, theodolite)	ELSEC 810, THEO-10B sn: 002208	FLUX-9408 THEO-10B sn: 160334	FLUX-9408 THEO-10B sn: 160326
Proton magnetometer	PMP-5 sn: 128 PMP-8 sn: 13/1998	PMP-8 sn: 21/2006	PMP-5 sn: 115
Frequency of measurements	6 per week	2 per week	2 per week

The results of absolute measurements are determined by means of a special computer package DIFLUX, which calculates the base values on the basis of data from the measurement protocol (Tomczyk 2008, this issue).

Table 3

Basic parameters of the instruments for absolute measurements

Fluxgate declinometer/inclinometer ELSEC 810 / THEO-10B	
Producer	ELSEC Oxford, UK
Mean square error of a horizontal direction	$\sigma_D \approx \pm 5''$
Mean square error of a zenith direction	$\sigma_I \approx \pm 5''$
Fluxgate declinometer/inclinometer FLUX-9408 / THEO-10B	
Producer (FLUX-9408).....	Institute of Geophysics Pol. Acad. Sc.
Mean square error of a horizontal direction	$\sigma_D \approx \pm 5''$
Mean square error of a zenith direction	$\sigma_I \approx \pm 5''$
Proton magnetometer model PMP-8	
Producer	Institute of Geophysics Pol. Acad. Sc.
Resolution	0.01 nT
Absolute accuracy	0.2 nT
Proton magnetometer model PMP-5	
Producer	Institute of Geophysics Pol. Acad. Sc.
Resolution	0.1 nT
Absolute accuracy	0.2 nT

Table 4

Mean errors of measurements of B_X , B_Y and B_Z in 2006

Observatory	Element	Set I		Set II	
		Number of measurements [n]	Mean error [mB]	Number of measurements [n]	Mean error [mB]
Belsk	B_X	304	± 0.5 nT	302	± 0.6 nT
	B_Y	304	± 0.5 nT	302	± 0.6 nT
	B_Z	304	± 0.3 nT	302	± 0.4 nT
Hel	B_X	82	± 0.7 nT	–	–
	B_Y	82	± 0.7 nT	–	–
	B_Z	82	± 0.4 nT	–	–
Hornsund	B_X	82	± 1.0 nT	–	–
	B_Y	79	± 1.3 nT	–	–
	B_Z	89	± 0.8 nT	–	–

The bases B_A of digital recording of elements X, Y and Z were calculated from the formula:

$$B_A = A - \varepsilon_A \times (a - 32768),$$

where A is the result of absolute measurement [nT], ε_A is the scale value of the recording [nT/bit], a is the recorded instantaneous value [bits].

For the digital records with a resolution of 16 bits, the values of $2^{15} = 32768$ bits, corresponding to zero voltages on inputs of these loggers, were adopted as the base levels.

Results of base determinations and the smoothed values adopted for further computations are depicted in Figs. 8, 9, 11, and 13 in the chapters describing individual observatories.

The mean random errors of a single base measurement, m_B , and the number of measurements n taken in 2006 are listed in Table 4.

Thermal coefficients of magnetic sensors are not taken into account in calculations, with a view to the following facts:

- tests made every few years indicated that the coefficients are very small, less than $0.2 \text{ nT}^\circ\text{C}$,
- the magnetic sensors are located in thermostat-controlled wooden boxes where the daily temperature variations are of the order of $0.1\text{-}0.2^\circ\text{C}$.

3.3 Recording of geomagnetic field variations

As we already mentioned, the continuous digital recordings of geomagnetic field variations in all the Polish observatories are performed by means of magnetometers PSM and digital loggers DR-2 (or DR-3). In spare sets, we use magnetometers PSM or LEMI. Both the main and spare sets record the components in the rectangular coordinate system X, Y, Z. At Belsk and Hel, continuous recording of the total magnetic field modulus F is performed as well. The basic parameters of the recording systems are listed in Table 5.

Magnetometers PSM

Magnetometers PSM were designed at the Institute of Geophysics PAS with the use of torsion quartz variometers of V. N. Bobrov system (Marianiuk 1977, Jankowski *et al.* 1984). In these magnetometers, the magnet's deflections in response to the magnetic field changes are transformed by means of photoelectric converters into the electric current changes. Owing to a strong negative feedback, the voltage changes on the output of the converter are in linear proportion to the magnetic field changes. The magnetometers PSM are characterized by good stability, of about 3-5 nT/year, and small noise, below 10 pT.

Magnetometers LEMI

Magnetometers LEMI were designed at the Lviv Centre of the Institute of Space Research (Ukraine). They employ flux-gate sensors. These magnetometers have been successfully used as auxiliary sets. Their stability is not much less than that of PSM's, and they are also characterized by good orthogonality of sensors and relatively small self noise.

Table 5

Basic instruments for the magnetic field variations recording

		Belsk	Hel	Hornsund
SET 1	Name of magnetometer	PSM	PSM	PSM
	Kind of sensor	Bobrov	Bobrov	Bobrov
	Type	PSM-8511-01P	PSM 8511-09P	PSM-8911-05P
	Sensor's orientation	XYZ	XYZ	XYZ
	Range	+/- 850 nT	+/- 850 nT	+/- 5000 nT
	Magnetometer's producer	Institute of Geophysics PAS	Institute of Geophysics PAS	Institute of Geophysics PAS
	Digital recorder Producer	DR-02,DR-03 EL-LAB	DR-03 EL-LAB	DR-02 EL-LAB
Sampling interval	5 s and 1 s	5 s	10 s	
SET 2	Name of magnetometer	PSM	PSM	LEMI
	Kind of sensor	Bobrov	Bobrov	fluxgate
	Type	PSM-8511-01P	PSM 8511-03P	LEMI-003/95
	Sensor's orientation	XYZ	XYZ	XYZ
	Range	+/- 820 nT	+/- 820 nT	+/- 10,000 nT
	Magnetometer's producer	Institute of Geophysics PAS	Institute of Geophysics PAS	Institute of Geophysics PAS
	Digital recorder Producer	DR-02,DR-03 EL-LAB	DR-02 EL-LAB	DR-02 EL-LAB
Sampling interval	5 s and 1 s	5 s	10 s	
Total field	Name of magnetometer	PMP-5	PMP-5	–
	Producer	Institute of Geophysics PAS	Institute of Geophysics PAS	Institute of Geophysics PAS
	Sampling interval	10 s	10 s	–

Proton magnetometers PMP-5 and PMP-8

Magnetometers PMP-5 and PMP-8 were designed at the Institute of Geophysics PAS. These are classical proton magnetometers, in which the precession signal is forced in a cycle of proton polarization by means of direct current. The resolution of magnetometers PMP-5 is 0.1nT, that of PMP-8 being 0.01nT. The stability of both magnetometers is better than 0.3 nT/year. More information about these instruments can be found on the page of Geophysical Instruments Laboratory at: http://dkag.igf.edu.pl/pmp8_ang.htm

Digital loggers DR-02 and DR-03

The digital loggers were designed in the early 1990s by the enterprise EL-LAB (Poland) especially for recording the long-term slow-changing variations. These are

independent instruments and their cooperation with the computer resolves itself to the read-out of data via the RS-232 interface. Model DR-03 is equipped in clock synchronized by a GPS.

3.4 Calibration of magnetic sensors

The verification of scale values of recording systems in all the three observatories was made by the classical electromagnetic method: electric currents were passed through calibration coils woven over variometers. The currents induce the magnetic field of precisely known intensity. The measurements are made at least few times a year.

The scale values of magnetometers PSM and LEMI, parameters of calibration coils of PSMs, and mutual orthogonality of sensors in PSMs and LEMIs is checked every few years in large calibration coils installed at the Belsk Observatory.

Table 6
Scale values adopted for computations in 2006

Observatory	Set	Period	Scale values		
			X [nT/bit]	Y [nT/bit]	Z [nT/bit]
Belsk	Set I	Jan 01-Dec 31	0.0250	0.0250	0.0249
	Set II	Jan 01-Dec 31	0.0248	0.0251	0.0250
Hel	Set I	Jan 01-Sep 25	0.0250	0.0250	0.0250
		Sep 26-Dec 21	0.0249	0.0248	0.0249
		Dec 22-Dec 31	0.0250	0.0248	0.0249
	Set II	Jan 01-Sep 26	0.0149	0.0147	0.0147
		Sep 27-Dec 21	0.0247	0.0246	0.0243
		Dec 22-Dec 31	0.0249	0.0249	0.0250
Hornsund	Set I	Jan 01-Dec 31	0.149	0.151	0.149
	Set II	Jan 01-Dec 31	0.307	0.308	0.307

3.5 Data treatment

In processing the results of digital recordings we used the software packet developed for the needs of an observatory operating in the INTERMAGNET network. This software makes it possible to perform, among other things, the following operations:

- conversion of magnetic data into the INTERMAGNET text format IMFV 1.22 and creation in this format of daily files containing one-minute means of X, Y, Z and F (authors: J. Reda and A. Pałka),
- automatic transmission of data, via the Internet, to the Institute of Geophysics PAS in Warsaw and data centers in Paris and Edinburgh (author: M. Neska),

- archivation of data and plotting of magnetograms (author: J. Reda),
- calculation of results of absolute measurements (author: S. Tomczyk),
- automatic calculation of geomagnetic indices K and C (Nowożyński *et al.* 1991). The indices are calculated with the use of ASm (Adaptive Smoothed) method, developed at the Institute of Geophysics PAS, and recommended by IAGA in 1991. The currently used program calculates the indices from one-minute means in the INTERMAGNET CD-ROM Data Format or in the IMFV 1.22 format. The program for calculation of indices may be taken from the INTERMAGNET page:
http://www.intermagnet.org/Software_e.html
- test printouts to check various parameters of recording adopted for calculation and a possibility of looking over current and past data curves or tables.

The diagrams illustrating the annual variations of X, Y, and Z, monthly variations of X, Y, Z and F, bases of recording sets as well as plots of K indices for 2006 were prepared with the use of program `imagplot.exe` provided to us by INTERMAGNET.

3.6 Data availability

The newest data from Belsk, Hel and Hornsund observatories can be viewed in graphic form through the WEB application

<http://rtbel.igf.edu.pl>

described by Nowożyński and Reda (2007).

On this page, the Belsk data appear with one-hour delay. The Hel data are made available a few hours after the end of the day, while the delay for Hornsund is 2 days on the average. The page makes it possible to view the archival data from any observatory belonging to the INTERMAGNET network (in the form of curves on the screen). It offers also a possibility of calculating the K indices according to the ASm method (Nowożyński *et al.* 1991) and E indices (Reda and Jankowski 2004).

On the Institute's server we also keep, for about ten years, the WEB application:

<http://www.igf.edu.pl/mag/index.html> (author: M. Jankowski)

This application enables a comparison of data from two Polish observatories, Belsk and Hel, and offers a possibility to get both the recent and archival data from these two observatories.

The current data (of status REPORTED) from all the three observatories can be found in INTERMAGNET centers in Edinburgh and Paris at the Internet addresses:

<http://www.intermagnet.bgs.ac.uk/cgi-bin/imagform>

http://obsmag.ipgp.jussieu.fr/cgi-bin/form_e

Data from Belsk, Hel and Hornsund are also available from the WDCs. Addresses of some WDC pages with magnetic data are the following:

WDC for Geomagnetism, Edinburgh

<http://www.wdc.bgs.ac.uk/catalog/master.html>

WDC for Geomagnetism, Kyoto.

<http://swdcd.db.kugi.kyoto-u.ac.jp/wdc/Sec3.html>

All the three observatories have in their archives the original data, whose sampling periods are listed in Table 5. For those interested, these data can be made available on request.

4 MAJOR EVENTS IN 2006

4.1 Belsk

The most important event in 2006 was the XII IAGA Workshop held at the Belsk Observatory (Reda 2007). The Workshop consisted of two parts: Measurement Session (Reda and Neska 2007) and Scientific Session. It was attended by over 100 scientists representing 32 countries from 5 continents.

4.2 Hel

In April 2006 there was a change of the personnel. Alicja Czyszek and Jarosław Czyszek terminated their work in the Observatory. The responsibility for the Observatory was given to Stanisław Wójcik. Since September 2006, half-time position was given to Anna Wójcik.

In September 2006, the recording sets were interchanged in their role. The spare set has become the basic set.

4.3 Hornsund

In summer 2006, the instrumentation for Schumann effect recording was reinstalled. An improved arrangement was installed in place of the former one.

5 CONTACT PERSON, POSTAL ADDRESS, CONTACT DETAILS

5.1 Belsk Observatory

Jan Reda
 Central Geophysical Observatory
 05-622 Belsk
 Poland
 Tel.: +48 486610830
 Fax: +48 486610840
 Email: jreda@igf.edu.pl
<http://belsk.igf.edu.pl>, <http://www.igf.edu.pl>

5.2 Hel Observatory

Stanisław Wójcik
 Geophysical Observatory
 ul. Sosnowa 1

84-150 Hel
 POLAND
 Tel./Fax +48 58 6750480
 Email: hel@igf.edu.pl
<http://www.igf.edu.pl>

5.3 Hornsund

Mariusz Neska
 Central Geophysical Observatory
 05-622 Belsk
 Poland
 Tel.: +48 486610833
 Fax: +48 486610840
 Email: nemar@igf.edu.pl
<http://hornsund.igf.edu.pl>, <http://www.igf.edu.pl>

6 PERSONNEL TAKING PART IN THE WORK OF BELSK, HEL AND HORNSUND OBSERVATORIES IN 2006

6.1 Belsk

- Jan Reda (head of Geomagnetic Laboratory at Belsk)
- Janusz Marianiuk (consulting)
- Mariusz Neska (data processing)
- Halina Suska (data processing, observer)
- Krzysztof Kucharski (observer)
- Benedykt Pachocki (observer)
- Józef Skowroński (observer)

6.2 Hel

- Stanisław Wójcik (head of Geophysical Observatory, since April 2006)
- Jarosław Czyszek (head of Geophysical Observatory, until April 2006)
- Alicja Czyszek (observer, data processing)
- Anna Wójcik (observer)
- Mariusz Neska (data processing)
- Jan Reda (data processing)

6.2 Hornsund

- Włodzimierz Glegolski (head of geomagnetic observations, until September 2006)
- Mariusz Neska (head of geomagnetic observations, since October 2006)

- Mirosław Stefański (observer)
- Jarosław Czyszek (observer)
- Piotr Modzel (observer)
- Jan Reda (data processing)

Literature

- Jankowski, J., and C. Sucksdorff (1996), *Guide for Magnetic Measurements and Observatory Practice*, IAGA, Warsaw, 235 pp.
- Jankowski, J., J. Marianiuk, A. Ruta, C. Sucksdorff, and M. Kivinen (1984), *Long-term stability of a torque-balance variometer with photoelectric converters in observatory practice*, *Geophys. Surv.* **6**, 3/4, 367-380.
- Jankowski, J., and J. Marianiuk (2007), *Past and present of Polish geomagnetic observatories*, *Publs. Inst. Geophys. Pol. Acad. Sc.* **C-99 (398)**, 20-31.
- Marianiuk, J. (1977), *Photoelectric converter for recording the geomagnetic field elements: construction and principle of operation*, *Publs. Inst. Geophys. Pol. Acad. Sc.* **C-4 (114)**, 57-73.
- Neska, M., and G. Satori (2006), *Schumann resonance observation at Polish Polar Station at Spitsbergen and in Central Geophysical Observatory in Belsk, Poland*, *Przeł. Geofiz.* **3-4**, 189-198, (in Polish).
- Nowożyński, K., T. Ernst and J. Jankowski (1991), *Adaptive smoothing method for computer derivation of K-indices*, *Geophys. J. Int.* **104**, 85-93.
- Nowożyński, K., and J. Reda (2007), *Comparison of observatory data in quasi-real time*, *Publs. Inst. Geophys. Pol. Acad. Sc.* **C-99 (398)**, 123-127.
- Reda, J., and M. Neska (2007), *Measurement Session during the XII IAGA Workshop at Belsk*, *Publs. Inst. Geophys. Pol. Acad. Sc.* **C-99 (398)**, 7-19.
- Reda, J., and J. Jankowski (2004), *Three hour activity index based on power spectra estimation*, *Geophys. J. Int.* **157**, 141-146.
- Reda, J. (editor) (2007), *XII IAGA Workshop on Geomagnetic Observatory Instruments, Data Acquisition and Processing, Belsk, 19-24 June 2006, Monographic Volume*, *Publs. Inst. Geophys. Pol. Acad. Sc.* **C-99 (398)**, 397 pp.
- Tomczyk, S. (2008), *DIFLUX software package for calculation of absolute measurement results*, *Publs. Inst. Geophys. Pol. Acad. Sc.* **C-100 (402)**, (this issue).
- Technical data PMP-8: http://dkag.igf.edu.pl/pmp8_ang.htm

*Received November 15, 2006
Accepted March 29, 2007*

TABLES AND PLOTS FOR BELSK OBSERVATORY

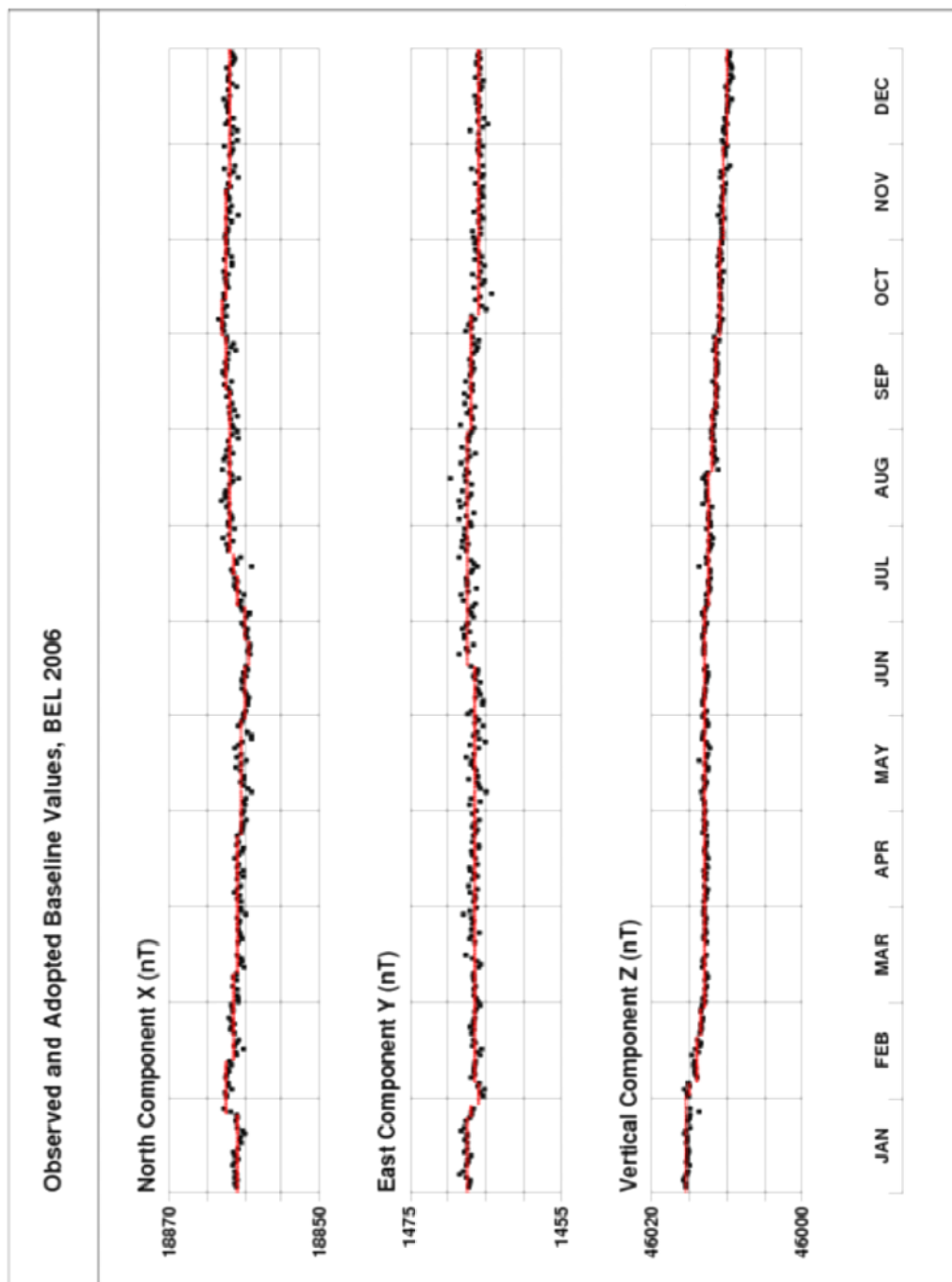

Fig. 8. Base values of set 1, Belsk 2006.

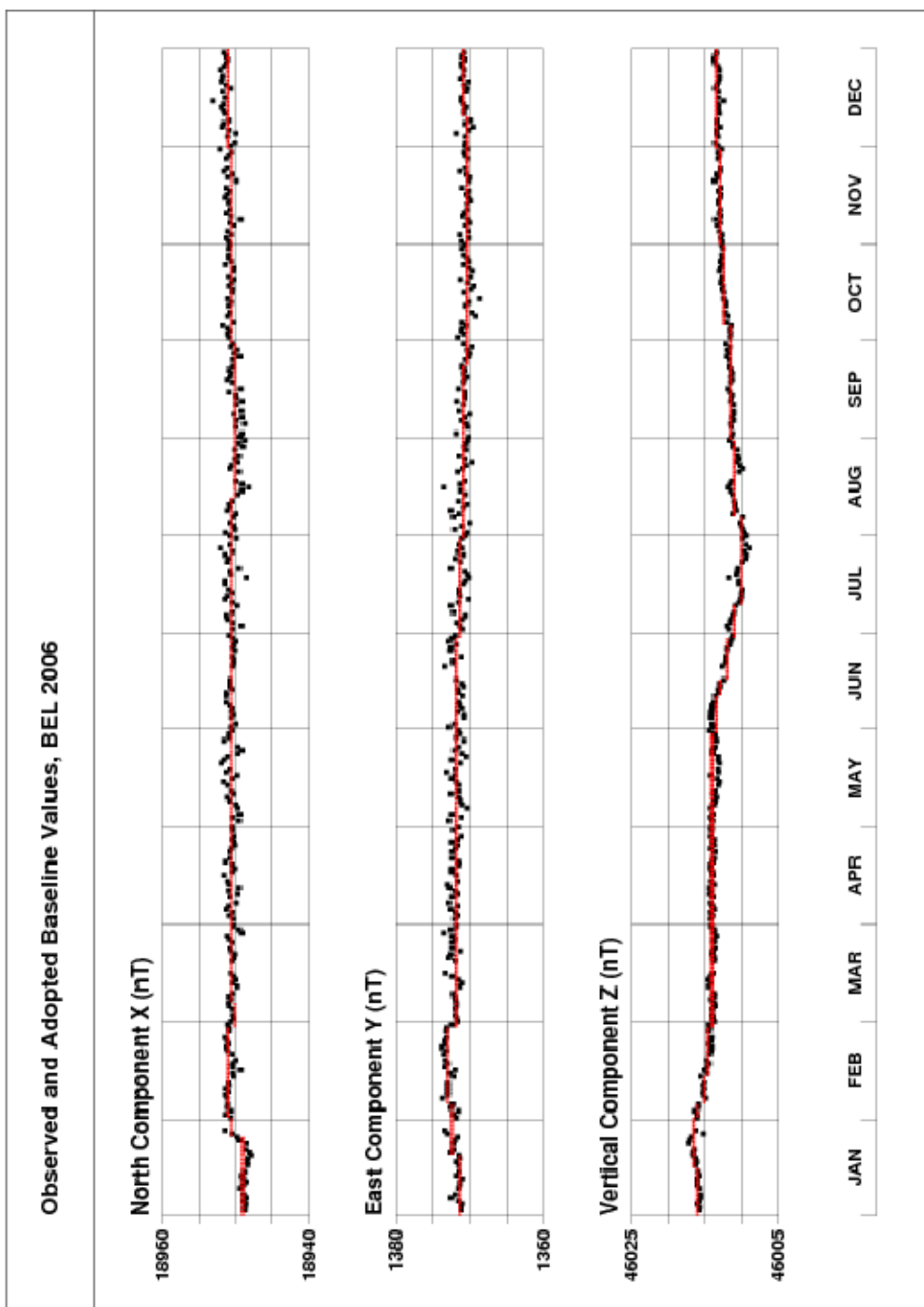

Fig. 9. Base values of set 2, Belsk 2006.

Annual mean values of magnetic elements in Belsk Observatory

No	Year	D [$^{\circ}$ ']	H [nT]	Z [nT]	X [nT]	Y [nT]	I [$^{\circ}$ ']	F [nT]
1	1966	2 04.2	18901.2	45023.3	18888.9	682.8	67 13.6'	48829.8
2	1967	2 05.6	18906.2	45047.7	18893.6	690.7	67 14.0	48854.3
3	1968	2 06.2	18917.8	45071.3	18905.5	694.6	67 13.8	48880.5
4	1969	2 06.3	18935.7	45093.5	18922.9	695.6	67 13.3	48907.9
5	1970	2 06.6	18953.0	45123.1	18940.2	697.7	67 13.0	48941.9
6	1971	2 06.6	18975.5	45146.4	18962.6	698.8	67 12.2	48972.1
7	1972	2 08.0	18991.6	45176.3	18978.4	706.7	67 11.9	49005.9
8	1973	2 10.2	19004.6	45210.8	18991.0	719.4	67 12.0	49042.8
9	1974	2 13.3	19016.3	45245.6	19002.0	737.1	67 12.2	49079.3
10	1975	2 16.4	19035.2	45273.5	19020.2	754.9	67 11.7	49112.4
11	1976	2 18.5g	19049.7	45306.9	19034.3	767.3	67 11.7	49148.8
12	1977	2 22.0	19062.1	45336.6	19045.8	787.4	67 11.7	49181.0
13	1978	2 27.4	19058.6	45375.7	19041.1	817.1	67 13.0	49215.7
14	1979	2 32.3	19061.4	45401.4	19042.7	844.2	67 13.5	49240.5
15	1980	2 37.2	19063.2	45418.4	19043.3	871.2	67 13.9	49256.8
16	1981	2 42.9	19047.1	45448.9	19025.7	902.0	67 15.7	49278.7
17	1982	2 48.3	19034.8	45478.8	19012.0	931.3	67 17.3	49301.6
18	1983	2 52.4	19032.6	45498.8	19008.7	953.8	67 18.0	49319.2
19	1984	2 56.9	19022.8	45519.8	18997.6	978.4	67 19.2	49334.8
20	1985	3 00.8	19015.2	45542.0	18988.9	999.5	67 20.3	49352.3
21	1986	3 05.1	19003.3	45570.4	18975.8	1022.8	67 21.8	49373.9
22	1987	3 08.5	18999.1	45592.7	18970.6	1041.2	67 22.7	49392.9
23	1988	3 12.4	18983.0	45626.4	18953.3	1062.0	67 24.6	49417.8
24	1989	3 15.9	18966.2	45662.1	18935.4	1080.3	67 26.6	49444.3
25	1990	3 18.8	18961.5	45684.3	18929.8	1095.9	67 27.5	49463.1
26	1991	3 22.2	18950.8	45709.3	18918.0	1114.1	67 28.8	49482.0
27	1992	3 25.3	18954.8	45726.1	18921.0	1131.2	67 29.1	49499.1
28	1993	3 29.8	18956.4	45743.7	18921.1	1156.0	67 29.4	49516.0
29	1994	3 34.8	18953.6	45772.4	18916.6	1183.3	67 30.4	49541.4
30	1995	3 39.8	18959.3	45796.8	18920.6	1211.5	67 30.7	49566.2
31	1996	3 45.0	18965.7	45821.9	18925.1	1240.6	67 30.9	49591.8
32	1997	3 50.9	18962.8	45856.9	18920.0	1272.7	67 32.0	49623.0
33	1998	3 57.3	18955.8	45897.1	18910.6	1307.6	67 33.6	49657.5
34	1999	4 02.5	18957.8	45930.6	18910.6	1336.4	67 34.3	49689.2
35	2000	4 07.8	18955.4	45968.7	18906.2	1365.4	67 35.5	49723.5
36	2001	4 13.0	18962.4	46004.8	18911.1	1394.2	67 36.0	49759.6
37	2002	4 18.4	18969.2	46043.6	18915.6	1424.4	67 36.6	49798.0
38	2003	4 24.2	18970.2	46089.6	18914.2	1456.7	67 37.7	49840.9
39	2004	4 29.4	18980.3	46121.0	18922.0	1486.0	67 37.9	49873.8
40	2005	4 34.7	18984.3	46154.6	18923.7	1515.5	67 38.5	49906.4
41	2006	4 39.8	18996.7	46177.2	18933.8	1544.3	67 38.3	49932.0

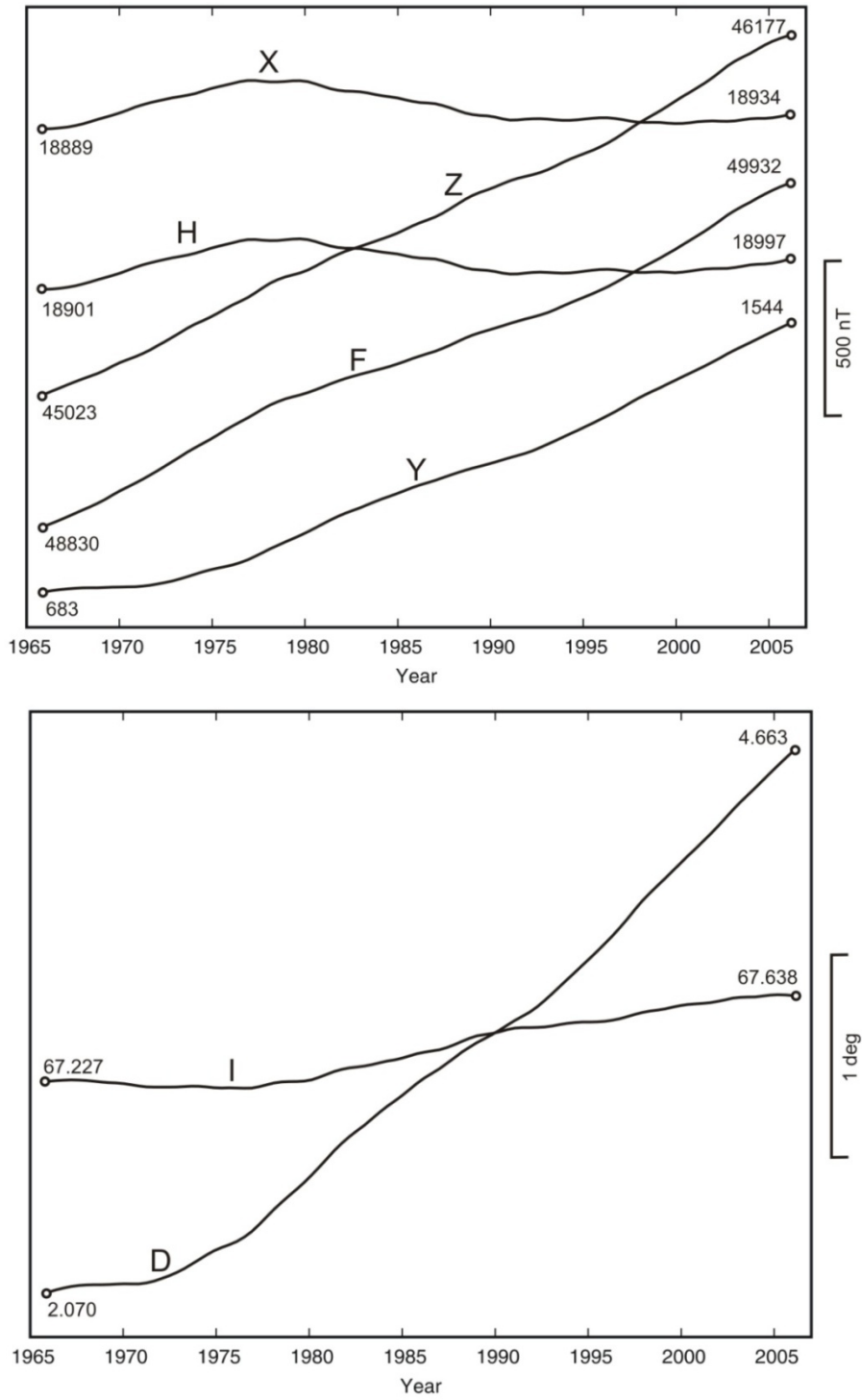

Fig. 10. Secular changes of H, X, Y, Z, F, D and I at Belsk.

MONTHLY AND YEARLY MEAN VALUES OF MAGNETIC ELEMENTS

BEL

2006

JAN FEB MAR APR MAY JUN JUL AUG SEP OCT NOV DEC MEAN

NORTH COMPONENT: 18500 + ... in nT

All days	432	434	434	428	438	438	439	433	435	435	433	426	434
Quiet days	435	438	439	439	438	441	440	437	441	441	440	436	439
Disturbed days	428	427	426	411	432	434	434	425	430	426	422	411	426

EAST COMPONENT: 1000 + ... in nT

All days	529	532	534	538	539	543	545	549	550	554	557	563	544
Quiet days	528	531	531	534	540	541	544	548	548	551	555	559	543
Disturbed days	532	534	538	540	541	543	547	551	553	558	559	569	547

VERTICAL COMPONENT: 46000 + ... in nT

All days	166	165	166	172	172	174	177	181	182	185	189	197	177
Quiet days	166	163	164	166	170	172	175	179	180	183	188	196	175
Disturbed days	167	167	168	176	173	175	178	185	182	185	192	195	179

Three-hour-range indices K and magnetic character figures C
 Belsk, January – March, 2006
 The limit of K = 9 is 450 nT

Day	January			February			March		
	K	ΣK	C	K	ΣK	C	K	ΣK	C
1	3112 3222	16	0	0111 2002	7	0	3223 3211	17	0
2	1122 1224	15	1	1112 1222	12	0	1011 1112	8	0
3	2100 1320	9	0	1012 0142	11	0	1110 1111	7	0
4	0100 0020	3	0	3211 1201	11	0	1111 0102	7	0
5	0011 1112	7	0	1021 1021	8	0	1010 0102	5	0
6	2211 2222	14	0	2312 4344	23	1	1112 3244	18	1
7	3121 2311	14	0	2111 1122	11	0	3321 1133	17	0
8	0011 1211	7	0	2101 0011	6	0	1101 2132	11	0
9	0001 0000	1	0	0011 1132	9	0	0000 1141	7	0
10	0000 1111	4	0	1001 0034	9	0	1223 3325	21	1
11	0011 1110	5	0	2221 2311	14	0	4232 1222	18	1
12	2111 0011	7	0	2311 1200	10	0	0122 1121	10	0
13	1011 1222	10	0	0000 1221	6	0	0011 1011	5	0
14	1001 1131	8	0	1000 0001	2	0	0011 1012	6	0
15	2111 0132	11	0	0123 2244	18	1	2223 2330	17	0
16	1222 3444	22	1	3222 2122	16	0	1212 1312	13	0
17	3322 2221	17	0	1211 1112	10	0	0011 1112	7	0
18	2224 1323	19	1	0001 1011	4	0	0134 3555	26	1
19	1012 2224	14	1	2121 2232	15	0	5443 4344	31	2
20	2112 2442	18	1	3223 5544	28	1	3333 2354	26	1
21	2212 1001	9	0	3324 4443	27	1	2322 2434	22	1
22	0022 2311	11	0	4332 3432	24	1	3222 1133	17	0
23	2333 3334	24	1	1112 1012	9	0	1111 1112	9	0
24	3222 1101	12	0	3112 2100	10	0	1101 1223	11	0
25	2111 1244	16	1	2111 0000	5	0	2211 1131	12	0
26	4413 3646	31	2	1211 2224	15	1	1102 2343	16	1
27	3222 3333	21	1	2111 1002	8	0	3200 1314	14	1
28	2211 1132	13	0	0011 1123	9	0	1211 2222	13	0
29	1111 0101	6	0				1212 1123	13	0
30	1010 0010	3	0				1111 1033	11	0
31	0100 1210	5	0				1112 2231	13	0

Three-hour-range indices K and magnetic character figures C

Belsk, April – June, 2006

The limit of K = 9 is 450 nT

Day	April			May			June		
	K	ΣK	C	K	ΣK	C	K	ΣK	C
1	0011 1101	5	0	0111 0000	3	0	2214 2332	19	1
2	0011 2111	7	0	1011 1121	8	0	2222 1321	15	0
3	0001 1111	5	0	1110 1122	9	0	2121 3211	13	0
4	1123 2345	21	1	1222 5433	22	1	1111 2110	8	0
5	4333 5442	28	1	3322 2211	16	0	1101 1211	8	0
6	1232 2222	16	0	2211 3544	22	1	2234 4353	26	1
7	1111 1001	6	0	3343 3232	23	1	4333 3434	27	1
8	1002 1122	9	0	2212 1111	11	0	3344 3543	29	1
9	5443 4355	33	2	1112 1111	9	0	3223 2332	20	1
10	3332 3332	22	1	0001 1123	8	0	2122 3332	18	1
11	2111 2112	11	0	3323 3344	25	1	2111 2212	12	0
12	1111 1110	7	0	4332 3223	22	1	1011 2212	10	0
13	1213 4433	21	1	3312 2232	18	1	1101 1111	7	0
14	3545 4544	34	2	3221 1111	12	0	1112 2234	16	1
15	3334 3554	30	1	1111 1112	9	0	2344 4443	28	1
16	3222 2332	19	1	1101 1101	6	0	2222 2242	18	1
17	2111 1224	14	1	2211 3312	15	0	2332 3331	20	1
18	4211 1212	14	1	2233 3532	23	1	0123 2211	12	0
19	2010 1111	7	0	1221 2222	14	0	1110 1100	5	0
20	0113 3210	11	0	2122 1221	13	0	2112 2210	11	0
21	1112 2422	15	1	3112 0231	13	0	0101 1121	7	0
22	4335 3221	23	1	3112 2324	18	1	1212 2221	13	0
23	1222 1112	12	0	2121 2111	11	0	0001 1120	5	0
24	3212 1012	12	0	1112 3200	10	0	0011 2221	9	0
25	3101 1211	10	0	1311 1123	13	0	2112 1211	11	0
26	1211 1110	8	0	1111 1220	9	0	0111 1110	6	0
27	1111 2222	12	0	1110 0101	5	0	1111 2322	13	0
28	3233 2112	17	0	1213 2122	14	0	3333 4233	24	1
29	1111 1012	8	0	0101 1112	7	0	3223 3432	22	1
30	0011 0000	2	0	1112 4332	17	1	2222 3322	18	1
31				2112 2222	14	0			

Three-hour-range indices K and magnetic character figures C
 Belsk, July – September, 2006
 The limit of K = 9 is 450 nT

Day	July			August			September		
	K	ΣK	C	K	ΣK	C	K	ΣK	C
1	1211 2110	9	0	3333 3412	22	1	3122 2455	24	1
2	0011 1111	6	0	2323 2213	18	1	3112 2233	17	0
3	1111 1121	9	0	2211 1122	12	0	2212 2223	16	0
4	1213 4333	20	1	1110 1011	6	0	4433 2333	25	1
5	4342 2233	23	1	2110 0110	6	0	2223 2442	21	1
6	3222 2222	17	0	1111 1201	8	0	1212 3231	15	0
7	2112 3321	15	0	3344 4543	30	1	2232 3321	18	1
8	1011 1111	7	0	3333 3321	21	1	2111 2212	12	0
9	0110 1113	8	0	2313 3213	18	1	1111 1010	6	0
10	2212 3332	18	1	1111 1113	10	0	1111 1221	10	0
11	0112 3333	16	0	2122 3221	15	0	2222 1101	11	0
12	3224 4221	20	1	2211 2321	14	0	2122 1122	13	0
13	2222 1111	12	0	0011 1111	6	0	1222 1110	10	0
14	2113 4433	21	1	1111 2211	10	0	1211 2111	10	0
15	0112 3111	10	0	0111 0222	9	0	0000 0010	1	0
16	0111 1111	7	0	1111 2111	9	0	1102 2220	10	0
17	1112 1221	11	0	0132 2223	15	0	2113 3253	20	1
18	0101 1210	6	0	2333 3432	23	1	4333 3454	29	1
19	1111 0101	6	0	2113 6456	28	2	2233 3321	19	1
20	1101 1111	7	0	5522 3322	24	1	2211 0120	9	0
21	1101 1110	6	0	2322 2335	22	1	0101 1112	7	0
22	1221 1112	11	0	4244 4542	29	1	0111 1121	8	0
23	2112 1112	11	0	2221 1111	11	0	1011 1235	14	1
24	1132 2312	15	0	2111 2322	14	0	5434 3233	27	1
25	3321 2213	17	0	0001 1001	3	0	2114 2113	15	1
26	3111 1201	10	0	1011 1022	8	0	1212 2222	14	0
27	1111 3334	17	1	2213 4543	24	1	2111 1210	9	0
28	5433 2312	23	1	3322 2333	21	1	1111 1023	10	0
29	2111 1221	11	0	3123 2321	17	0	3011 2231	13	0
30	1211 1112	10	0	1122 2332	16	0	1344 2323	22	1
31	2334 4332	24	1	1121 2333	16	0			

Three-hour-range indices K and magnetic character figures C

Belsk, October – December, 2006

The limit of K = 9 is 450 nT

Day	October			November			December		
	K	ΣK	C	K	ΣK	C	K	ΣK	C
1	4433 3423	26	1	1211 3332	16	0	1111 2242	14	1
2	2122 2232	16	0	3101 2343	17	1	1101 1111	7	0
3	2222 4313	19	1	2112 3221	14	0	1111 0121	8	0
4	1111 1321	11	0	2212 2232	16	0	0000 0021	3	0
5	1111 1122	10	0	0122 2211	11	0	0004 1112	9	0
6	0022 0112	8	0	0011 1112	7	0	4334 4354	30	1
7	1111 2345	18	1	0000 0010	1	0	4433 3534	29	1
8	3112 2222	15	0	1000 0010	2	0	3443 3353	28	1
9	1211 0022	9	0	1000 2345	15	1	1210 0334	14	1
10	1111 0111	7	0	4435 4353	31	2	2322 4534	25	1
11	1111 1110	7	0	3333 3543	27	1	3332 2124	20	1
12	2011 2213	12	0	3222 2011	13	0	3532 4554	31	2
13	2233 3465	28	2	1110 0000	3	0	3321 1123	16	0
14	4323 2545	28	1	0111 2223	12	0	3222 5566	31	2
15	2322 3342	21	1	3211 1223	15	0	8654 6554	43	2
16	2111 2233	15	0	4221 1110	12	0	3212 1343	19	1
17	1111 1111	8	0	2211 2111	11	0	2111 1231	12	0
18	1111 0031	8	0	0000 0101	2	0	1212 2334	18	1
19	0102 1101	6	0	2212 1111	11	0	3323 3332	22	1
20	2132 3433	21	1	0010 1000	2	0	4332 4455	30	1
21	4322 3543	26	1	1011 1000	4	0	4333 4432	26	1
22	2322 3343	22	1	0012 2122	10	0	3334 3343	26	1
23	1111 1112	9	0	1123 3444	22	1	2232 3442	22	1
24	1121 2132	13	0	2332 3232	20	1	2222 3342	20	1
25	2112 1110	9	0	3222 3553	25	1	3221 2311	15	0
26	1111 1110	7	0	3332 2244	23	1	1111 3210	10	0
27	1101 0133	10	0	2123 1331	16	0	1111 0111	7	0
28	1122 3445	22	1	1112 2323	15	0	0000 0132	6	0
29	4332 3455	29	1	2322 1122	15	0	1101 0121	7	0
30	4223 2322	20	1	3333 6422	26	2	1011 1121	8	0
31	2011 1223	12	0				1000 0112	5	0

BEL

K-Indices

2006

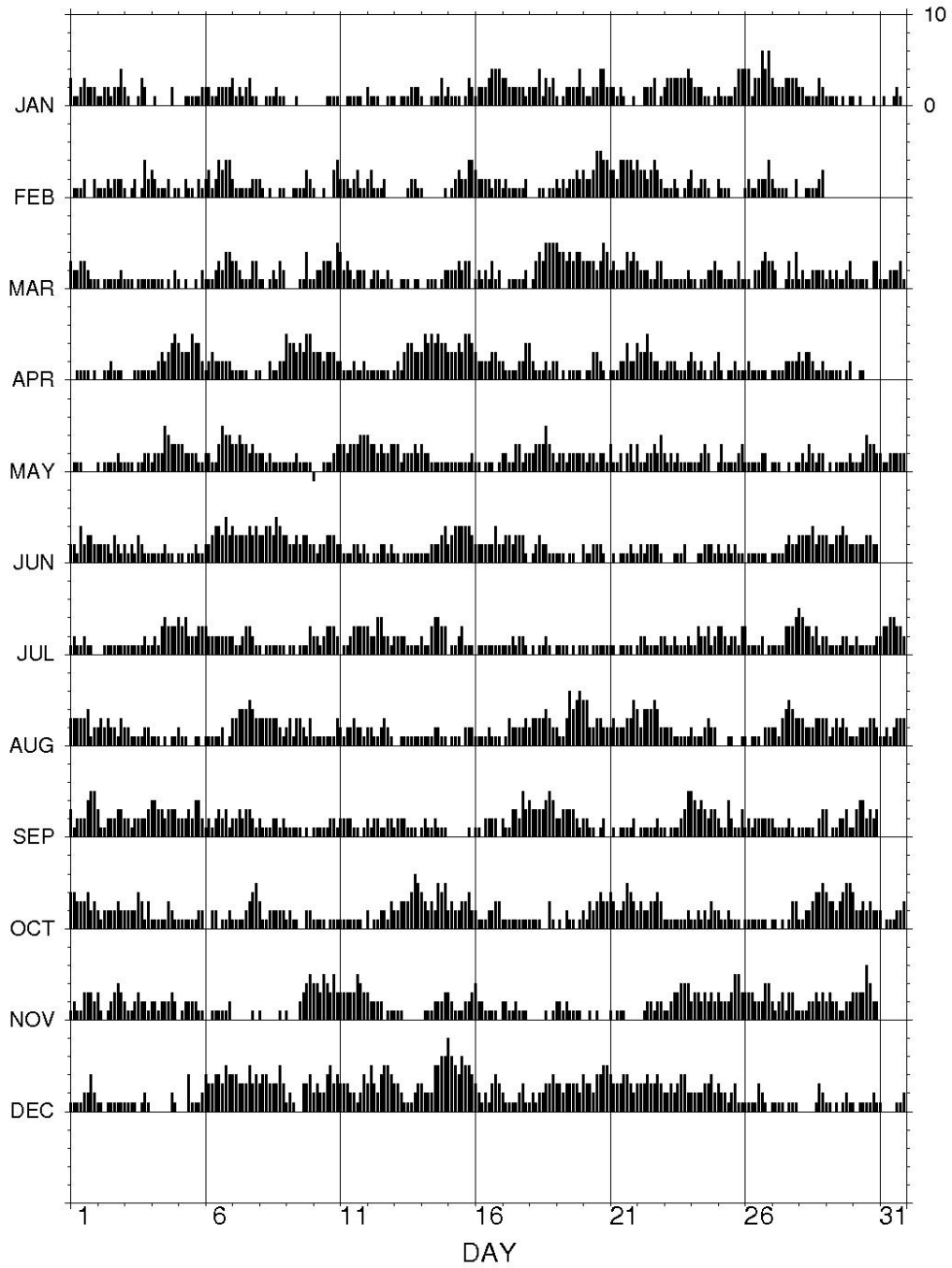

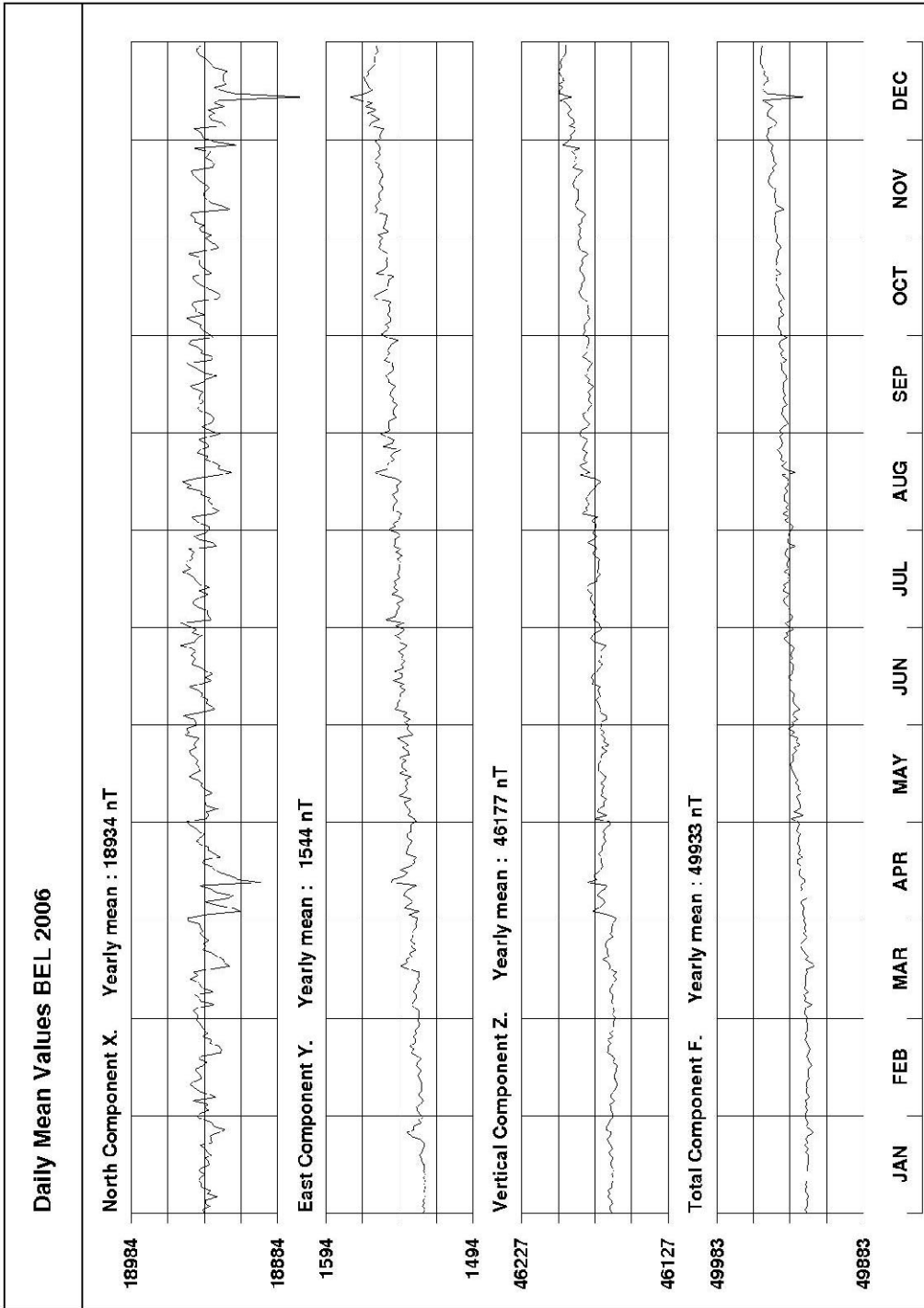

BEL - Hourly Mean Values

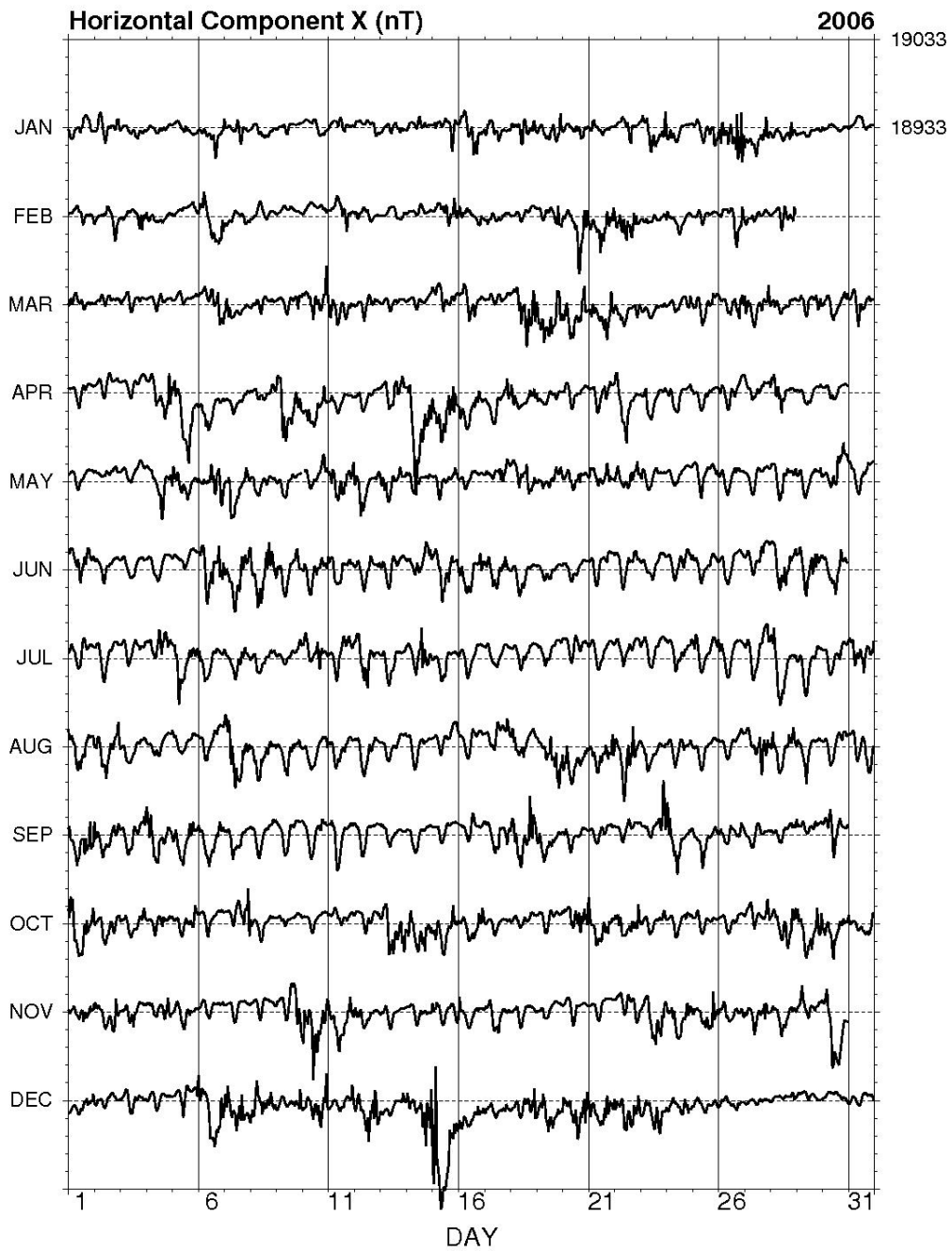

BEL - Hourly Mean Values

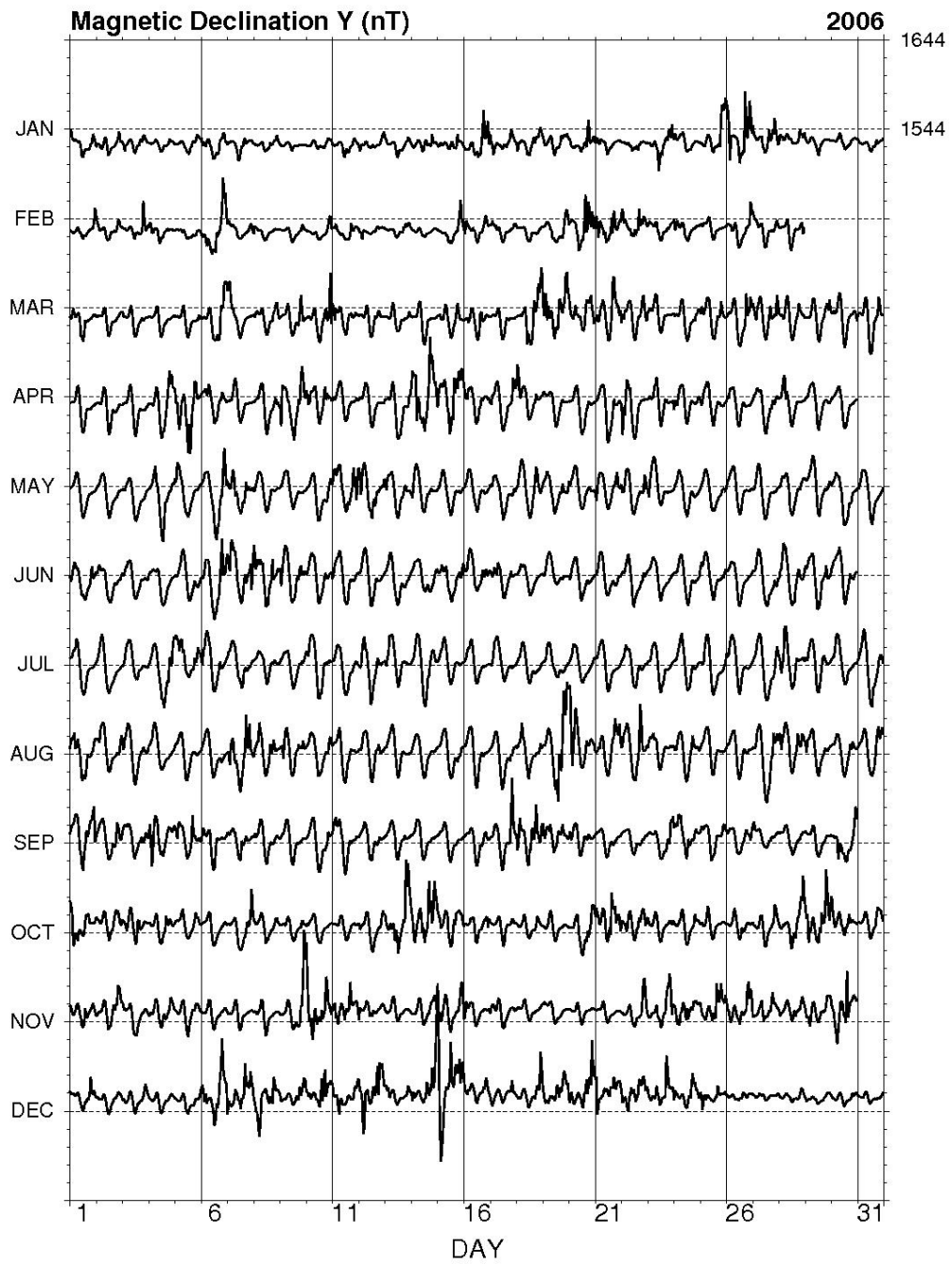

BEL - Hourly Mean Values

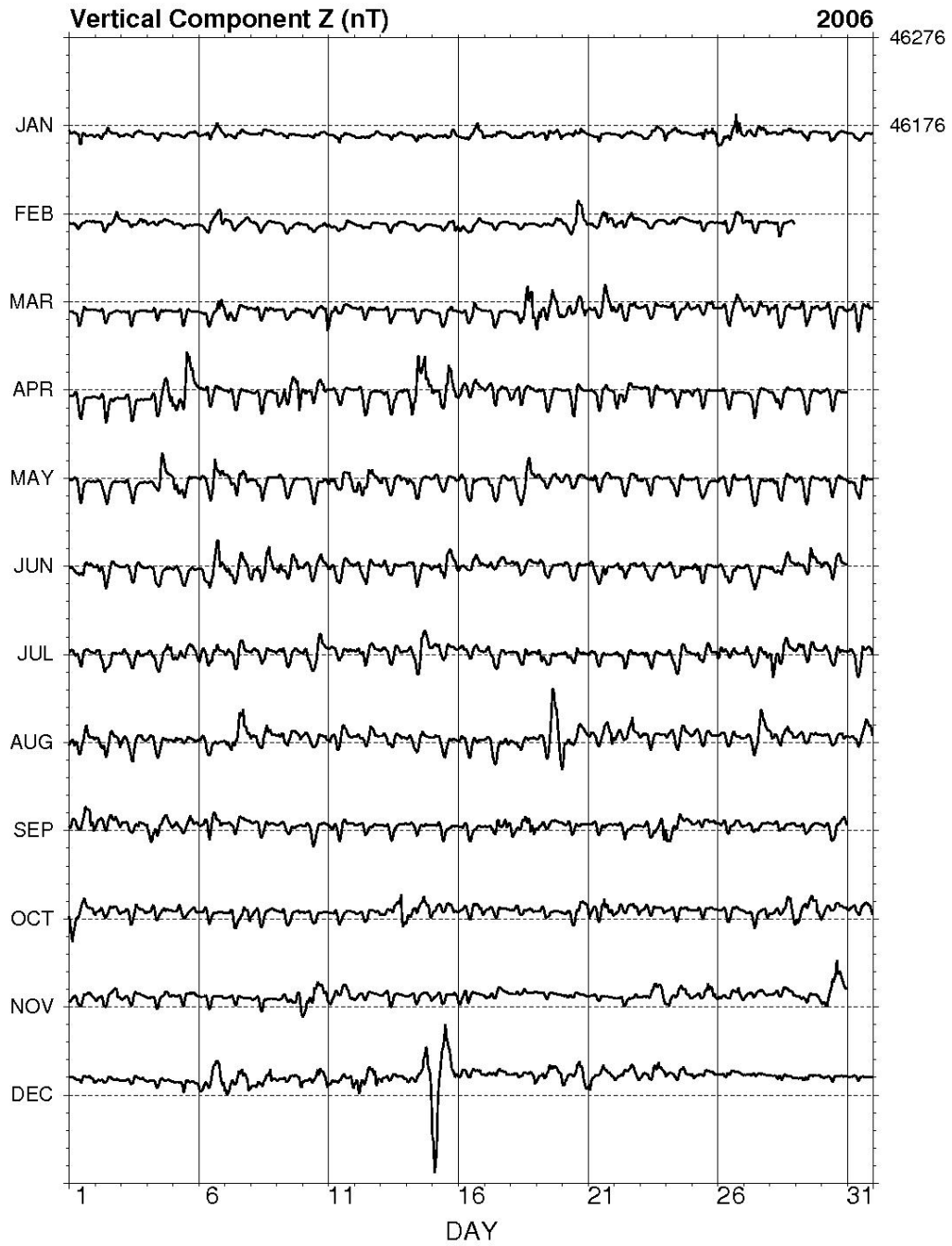

BEL - Hourly Mean Values

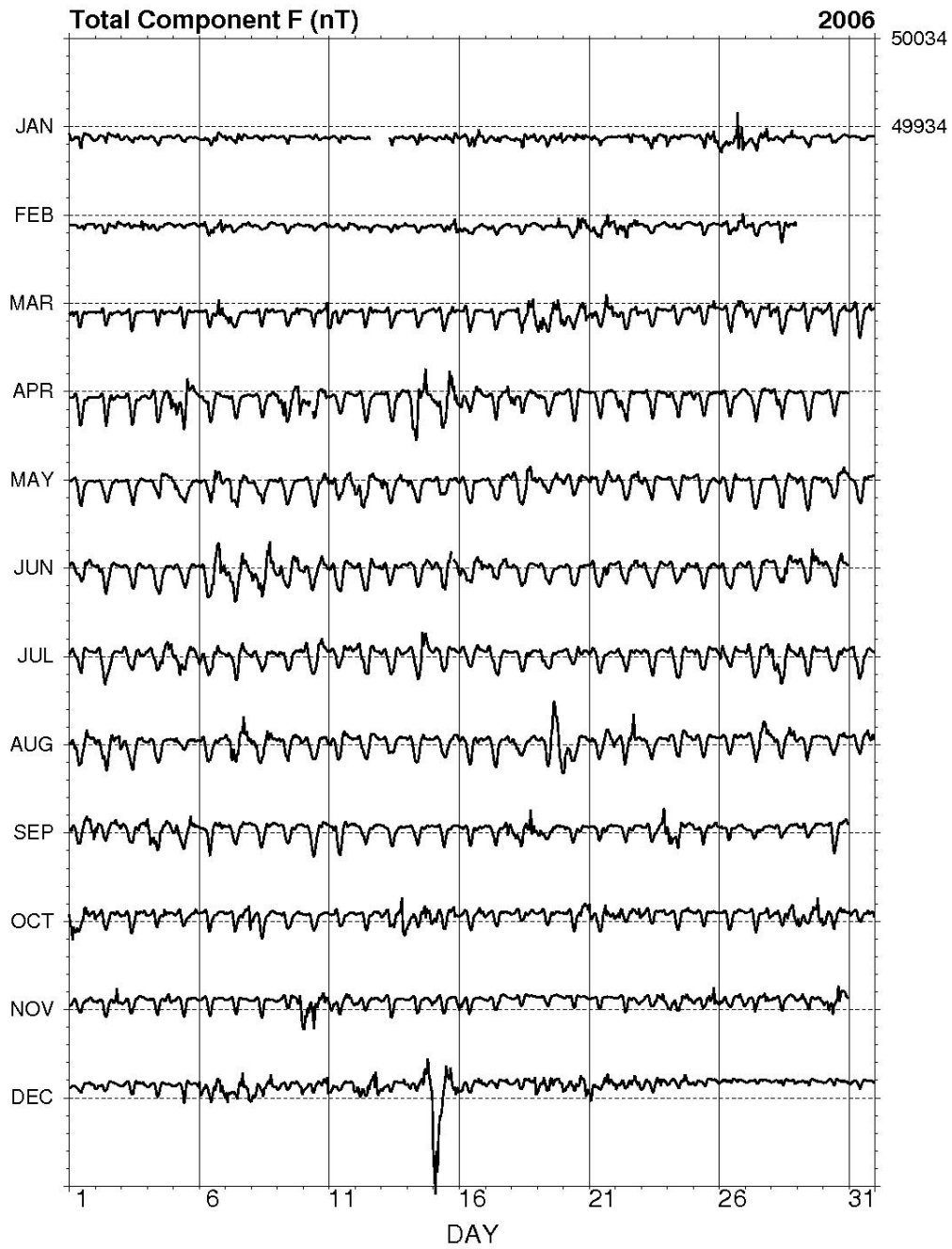

TABLES AND PLOTS FOR HEL OBSERVATORY

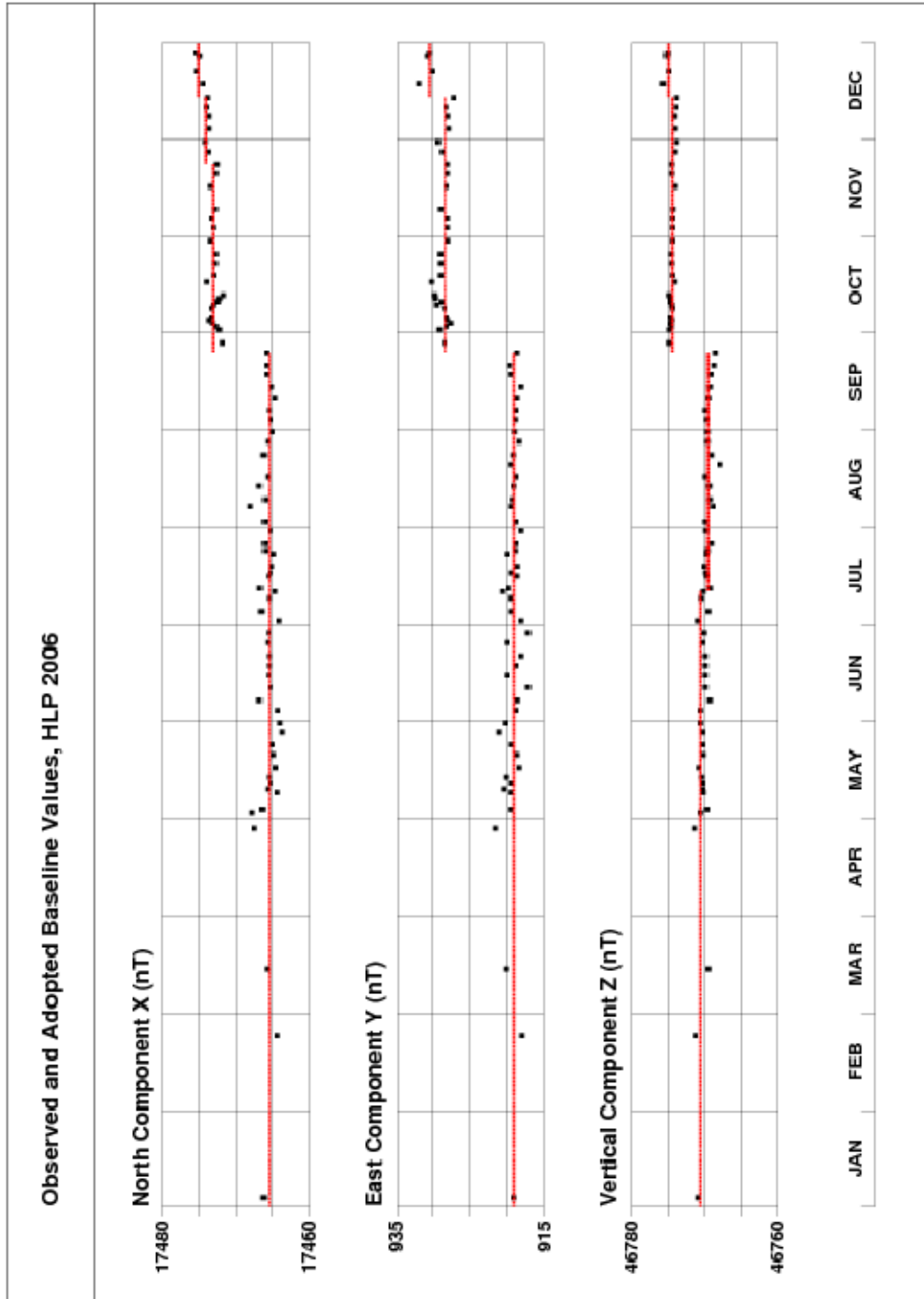

Fig. 11. Base values of set 1, Hel 2006.

Annual mean values of magnetic elements in Hel Observatory

No	Year	D [$^{\circ}$ ']	H [nT]	Z [nT]	X [nT]	Y [nT]	I [$^{\circ}$ ']	F [nT]
1	1953	-0 14.5	17388	45327	17388	-73	69 00.8	48548
2	1954	-0 10.0	17394	45374	17394	-51	69 01.5	48594
3	1955	-0 04.2	17379	45430	17379	-21	69 03.9	48640
4	1956	0 03.9	17371	45450	17371	20	69 05.0	48656
5	1957	0 05.7	17372	45475	17372	29	69 05.5	48680
6	1958	0 10.2	17380	45535	17380	52	69 06.5	48739
7	1959	0 14.7	17390	45565	17390	74	69 06.6	48771
8	1960	0 17.6	17402	45602	17402	89	69 06.8	48810
9	1961	0 19.8	17422	45625	17422	100	69 06.0	48838
10	1962	0 22.7	17438	45647	17438	115	69 05.5	48864
11	1963	0 26.5	17449	45663	17448	134	69 05.2	48883
12	1964	0 28.6	17464	45676	17463	145	69 04.6	48901
13	1965	0 30.0	17476	45692	17475	152	69 04.2	48920
14	1966	0 31.6	17485	45710	17484	161	69 04.0	48940
15	1967	0 33.3	17492	45743	17491	169	69 04.4	48973
16	1968	0 34.4	17502	45769	17501	175	69 04.4	49001
17	1969	0 34.3	17524	45792	17523	175	69 03.5	49030
18	1970	0 34.8	17542	45824	17541	178	69 03.2	49067
19	1971	0 35.7	17565	45849	17564	182	69 02.3	49098
20	1972	0 36.1	17579	45880	17578	184	69 02.1	49132
21	1973	0 38.5	17595	45912	17594	197	69 01.9	49168
22	1974	0 41.9	17606	45951	17605	215	69 02.2	49208
23	1975	0 45.0	17625	45984	17623	231	69 01.7	49246
24	1976	0 49.6	17639	46015	17637	254	69 01.6	49280
25	1977	0 55.0	17651	46045	17649	282	69 01.5	49312
26	1978	1 00.2	17646	46085	17643	309	69 02.9	49349
27	1979	1 05.1	17651	46112	17648	334	69 03.2	49375
28	1980	1 11.5	17653	46127	17649	367	69 03.5	49390
29	1981	1 17.5	17637	46156	17632	398	69 05.2	49411
30	1982	1 23.4	17620	46184	17615	427	69 07.1	49431
31	1983	1 28.6	17614	46200	17608	454	69 07.8	49444
32	1984	1 33.5	17602	46219	17596	479	69 09.1	49457
33	1985	1 37.9	17591	46239	17584	501	69 10.3	49472
34	1986	1 42.7	17579	46263	17571	525	69 11.6	49490
35	1987	1 46.3	17572	46285	17564	543	69 12.6	49508
36	1988	1 51.0	17555	46318	17546	567	69 14.6	49533

No	Year	D [°']	H [nT]	Z [nT]	X [nT]	Y [nT]	I [°']	F [nT]
37	1989	1 55.5	17535	46352	17525	589	69 16.7	49558
38	1990	1 58.4	17527	46374	17516	604	69 17.8	49575
39	1991	2 00.6	17513	46398	17502	614	69 19.3	49593
40	1992	2 03.9	17515	46416	17504	631	69 19.6	49611
41	1993	2 10.0	17516	46428	17503	662	69 19.8	49622
42	1994	2 15.9	17512	46456	17498	692	69 20.7	49647
43	1995	2 21.3	17518	46481	17503	720	69 21.0	49672
44	1996	2 26.6	17523	46506	17507	747	69 21.2	49698
45	1997	2 32.9	17519	46539	17502	779	69 22.3	49727
46	1998	2 39.8	17512	46581	17493	814	69 23.8	49764
47	1999	2 45.4	17511	46615	17491	842	69 24.7	49796
48	2000	2 51.9	17507	46657	17485	875	69 25.9	49833
49	2001	2 57.7	17515	46692	17492	905	69 26.2	49869
50	2002	3 03.7	17520	46730	17495	936	69 26.9	49906
51	2003	3 10.8	17519	46777	17492	972	69 28.1	49950
52	2004	3 16.6	17529	46809	17500	1002	69 28.2	49983
53	2005	3 22.3	17531	46843	17501	1031	69 28.9	50016
J	2006.	0 -1.5	-2	9	-2	-8	0 0.6	7
54	2006	3 29.9	17550	46859	17517	1071	69 28.1	50038

Note: Since 2006 the observatory has stopped introducing the so-called historical corrections. These corrections were related, among other things, with variable location of the instruments for absolute measurements. In the 2006.0 line we include the jump value J relating to the neglect of historical corrections. The jump values are defined as follows:

$$\text{jump value J} = \text{old site value} - \text{new site value}$$

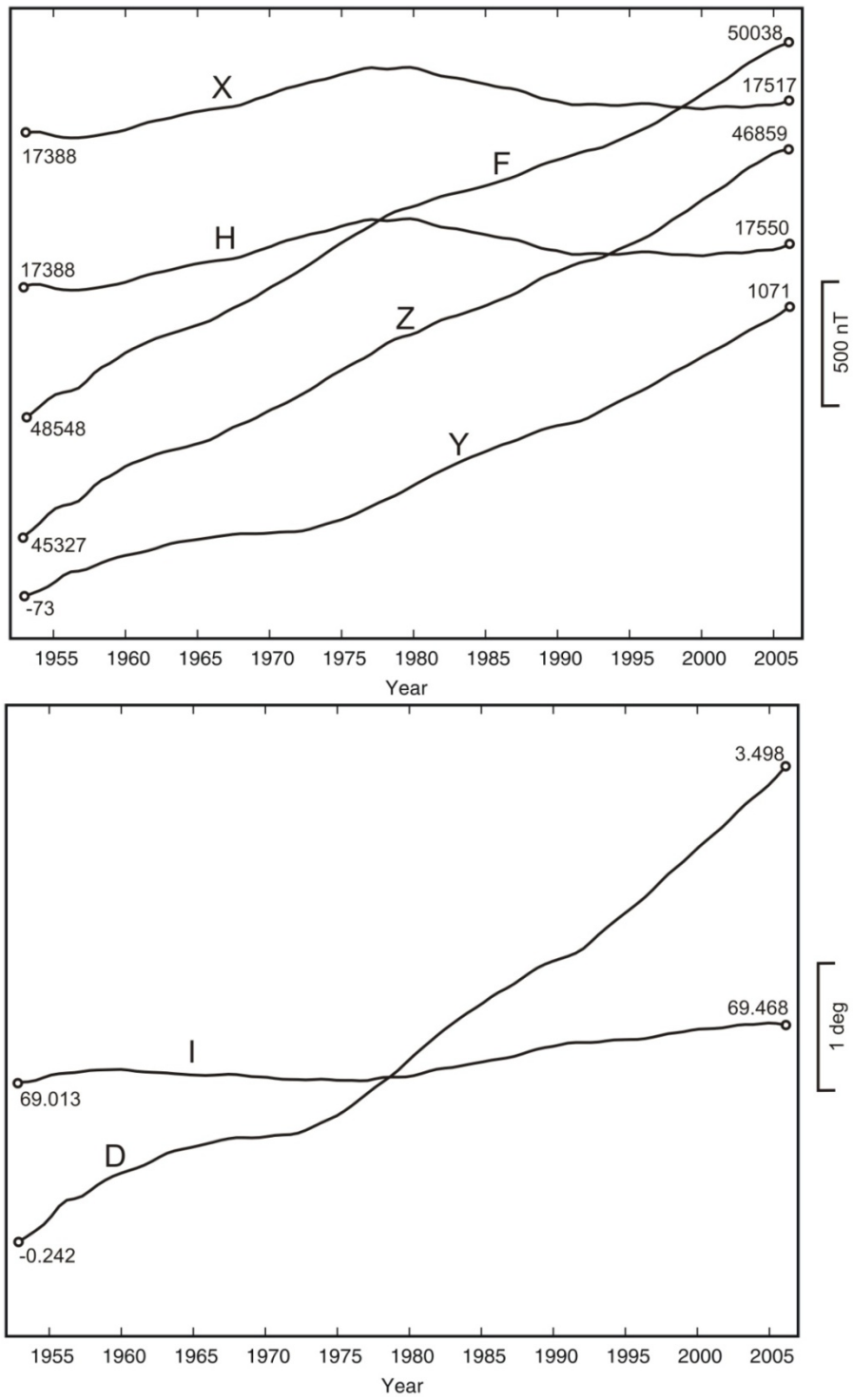

Fig. 12. Secular changes of H, X, Y, Z, F, D and I at Hel.

MONTHLY AND YEARLY MEAN VALUES OF MAGNETIC ELEMENTS

	JAN	FEB	MAR	APR	MAY	JUN	JUL	AUG	SEP	OCT	NOV	DEC	MEAN	
HLP													2006	
	NORTH COMPONENT: 17000 + ... in nT													
All days	512	514	514	509	523	524	525	519	520	518	516	510	517	
Quiet days	515	518	518	520	524	527	526	522	525	523	523	519	522	
Disturbed days	506	508	507	493	518	521	520	512	516	509	506	495	509	
	EAST COMPONENT: 1000 + ... in nT													
All days	54	56	56	60	64	66	70	72	75	78	83	86	92	71
Quiet days	53	55	55	56	60	67	68	71	75	76	80	84	88	69
Disturbed days	57	58	58	64	66	68	70	73	78	81	87	88	99	74
	VERTICAL COMPONENT: 46500 + ... in nT													
All days	344	344	347	354	355	359	361	365	365	366	371	378	359	
Quiet days	343	343	344	349	353	357	359	363	364	364	370	377	357	
Disturbed days	344	346	348	358	357	361	361	369	365	365	373	375	360	

Three-hour-range K-indices
 Hel, January – March, 2006
 The limit of $K = 9$ is 550 nT

Day	January		February		March	
	K	ΣK	K	ΣK	K	ΣK
1	2101 2222	12	0010 1003	5	3122 3101	13
2	2112 1223	14	1011 0112	7	1011 1002	6
3	2000 1220	7	0001 0142	8	1010 1111	6
4	0001 0010	2	3211 1101	10	1111 0002	6
5	0001 1111	5	1011 1021	7	1000 0101	3
6	2211 2222	14	2312 4244	22	1012 3244	17
7	2111 2301	11	2100 1122	9	3321 1132	16
8	0011 1101	5	2001 0011	5	1001 2132	10
9	0001 0000	1	0011 1022	7	0100 0131	6
10	0000 0010	1	1000 0034	8	2223 3325	22
11	0001 1110	4	1111 2310	10	3222 1212	15
12	2011 0011	6	2311 1200	10	0122 2120	10
13	1000 1211	6	0000 0221	5	0001 0011	3
14	1001 1131	8	0000 0001	1	0002 1002	5
15	2101 0132	10	0123 2244	18	2122 2330	15
16	1223 3444	23	3322 1122	16	1212 1312	13
17	2311 2121	13	1211 1112	10	0001 1012	5
18	22-13 1323	-1	0001 1011	4	0134 3555	26
19	1012 2224	14	2121 2232	15	5443 4344	31
20	2101 2442	16	2223 5544	27	3333 3353	26
21	2212 1000	8	3324 4333	25	2322 2433	21
22	0012 2301	9	4333 2432	24	3222 1133	17
23	2233 3334	23	1112 1012	9	1111 1112	9
24	3221 1101	11	3122 1100	10	1102 2223	13
25	2111 1244	16	2110 0000	4	2211 1230	12
26	4423 3645	31	1211 2223	14	1002 2243	14
27	3223 2333	21	2011 1002	7	3301 1313	15
28	2111 1132	12	0011 1123	9	1211 1222	12
29	1010 0001	3			1112 1123	12
30	1000 0010	2			1001 1033	9
31	0100 1201	5			1012 2131	11

Three-hour-range K-indices

Hel, April – June, 2006

The limit of K = 9 is 550 nT

Day	April		May		June	
	K	ΣK	K	ΣK	K	ΣK
1	0001 1101	4	0111 0000	3	2213 2332	18
2	0011 2011	6	1011 1121	8	2222 2211	14
3	0000 1111	4	1000 0111	4	2121 3211	13
4	0123 2344	19	1222 5433	22	0111 1110	6
5	3423 5342	26	3222 2201	14	1101 1211	8
6	1232 2122	15	1212 3444	21	1134 4353	24
7	1011 1001	5	2343 3232	22	4333 4434	28
8	1002 1122	9	2212 1010	9	4334 3433	27
9	5443 4356	34	0012 1-1-12	-1	3223 2332	20
10	3332 3432	23	0001 1123	8	2122 3332	18
11	2112 2102	11	2333 4334	25	2112 2212	13
12	0101 0010	3	4333 3223	23	1012 2211	10
13	1113 4433	20	3212 3232	18	1001 1111	6
14	3545 4543	33	3222 2111	14	1012 2233	14
15	3334 3544	29	1111 1112	9	2344 4443	28
16	3222 2331	18	0101 1101	5	2222 2232	17
17	2011 1124	12	2211 3311	14	2332 3321	19
18	4211 0112	12	2223 3532	22	0223 2211	13
19	2000 1110	5	1222 2222	15	2111 1000	6
20	0103 3210	10	2112 2221	13	2112 2210	11
21	1002 3412	13	3112 1231	14	0001 2111	6
22	4335 3221	23	3112 2324	18	1212 2221	13
23	1222 1113	13	3122 2100	11	0010 1110	4
24	3212 1002	11	0112 2200	8	0001 2221	8
25	3101 2211	11	0311 1022	10	2112 1211	11
26	1111 1100	6	1111 1210	8	0001 1100	3
27	1111 2222	12	1011 0001	4	1112 3322	15
28	3233 2112	17	1213 2122	14	3333 4233	24
29	1011 0011	5	0001 1112	6	3223 3332	21
30	0001 0000	1	1012 4332	16	2222 3322	18
31			2111 3221	13		

Three-hour-range K-indices
 Hel, July – September, 2006
 The limit of $K = 9$ is 550 nT

Day	July		August		September	
	K	ΣK	K	ΣK	K	ΣK
1	1212 2110	10	3333 3412	22	3022 3355	23
2	0010 1110	4	2223 3213	18	3112 2233	17
3	1111 1211	9	2211 1122	12	2212 2223	16
4	1112 4334	19	1100 0011	4	4433 2333	25
5	4343 3233	25	2110 0111	7	2223 2432	20
6	3222 2222	17	0011 1201	6	1112 3231	14
7	2112 3321	15	3345 4543	31	2222 3220	15
8	1010 0111	5	2333 3321	20	2111 2112	11
9	0100 1113	7	1313 3113	16	1010 0000	2
10	2112 3332	17	1001 1113	8	1011 1221	9
11	0112 3333	16	2112 3211	13	2222 2101	12
12	3224 4221	20	2211 2321	14	1123 1121	12
13	2222 2011	12	0001 1111	5	1222 1110	10
14	1113 5433	21	1001 2111	7	1211 2111	10
15	0111 3211	10	0102 0212	8	1010 0000	2
16	0110 1111	6	1102 2111	9	0002 2120	7
17	1111 1120	8	0022 2223	13	1113 3253	19
18	0101 1210	6	2333 3423	23	4333 3354	28
19	0100 0001	2	2114 5555	28	2233 3221	18
20	1101 2112	9	5522 3332	25	2211 0020	8
21	1101 1010	5	2321 2334	20	0001 1111	5
22	1211 1102	9	4244 4542	29	0001 1121	6
23	2111 1211	10	2221 1011	10	1001 1235	13
24	1122 2312	14	2011 2312	12	5434 3223	26
25	3221 2223	17	0000 0000	0	2114 2113	15
26	3111 2201	11	1011 1022	8	1212 2222	14
27	1111 3333	16	2113 4543	23	2122 1110	10
28	4433 3311	22	3322 3333	22	1011 1013	8
29	2111 1121	10	3123 2321	17	3000 2230	10
30	1210 1102	8	1122 2232	15	0344 3323	22
31	2234 4322	22	1121 2333	16		

Three-hour-range K-indices
 Hel, October – December, 2006
 The limit of K = 9 is 550 nT

Day	October		November		December	
	K	ΣK	K	ΣK	K	ΣK
1	4433 3423	26	1211 3222	14	1011 1232	11
2	2122 2132	15	2101 2343	16	0000 1011	3
3	2122 3313	17	2112 3220	13	1100 0121	6
4	1110 1321	10	2212 1222	14	0000 0011	2
5	1011 1022	8	0122 1211	10	0004 0111	7
6	0012 0011	5	0010 0012	4	4334 4354	30
7	0011 2334	14	0000 0000	0	4433 3534	29
8	2112 2221	13	1000 0000	1	3434 3343	27
9	1211 1022	10	1000 1344	13	1210 0334	14
10	1111 0001	5	4435 4253	30	2322 4534	25
11	1011 1110	6	3333 3543	27	3322 2124	19
12	2011 2113	11	3212 2011	12	3432 4444	28
13	2233 3365	27	11-10 0000	-1	3211 1122	13
14	4323 2544	27	011-1 1223	-1	3222 5557	31
15	2322 2342	20	32-1-1 1123	-1	7644 6554	41
16	2111 2233	15	422-1 0100	-1	3212 1343	19
17	1101 1111	7	2101 2111	9	2011 1131	10
18	1110 0021	6	0000 0101	2	1112 2334	17
19	0102 1000	4	1112 0011	7	2223 3232	19
20	2132 3333	20	0000 1000	1	4322 3455	28
21	4322 3543	26	1000 1000	2	43-1-1 -1432	-1
22	2322 3343	22	0013 2122	11	3234 3333	24
23	1011 0112	7	1122 3444	21	2232 3432	21
24	0022 2122	11	2332 3232	20	2122 3342	19
25	1111 1100	6	2222 2553	23	3221 2311	15
26	0101 1110	5	3222 2243	20	1121 3210	11
27	1001 0133	9	2122 1332	16	0000 0101	2
28	1122 2344	19	1111 2213	12	0000 0032	5
29	4332 3345	27	2321 0122	13	1100 0111	5
30	4223 1321	18	3333 5422	25	1001 1111	6
31	2000 1223	10			1001 0112	6

HLP

K-Indices

2006

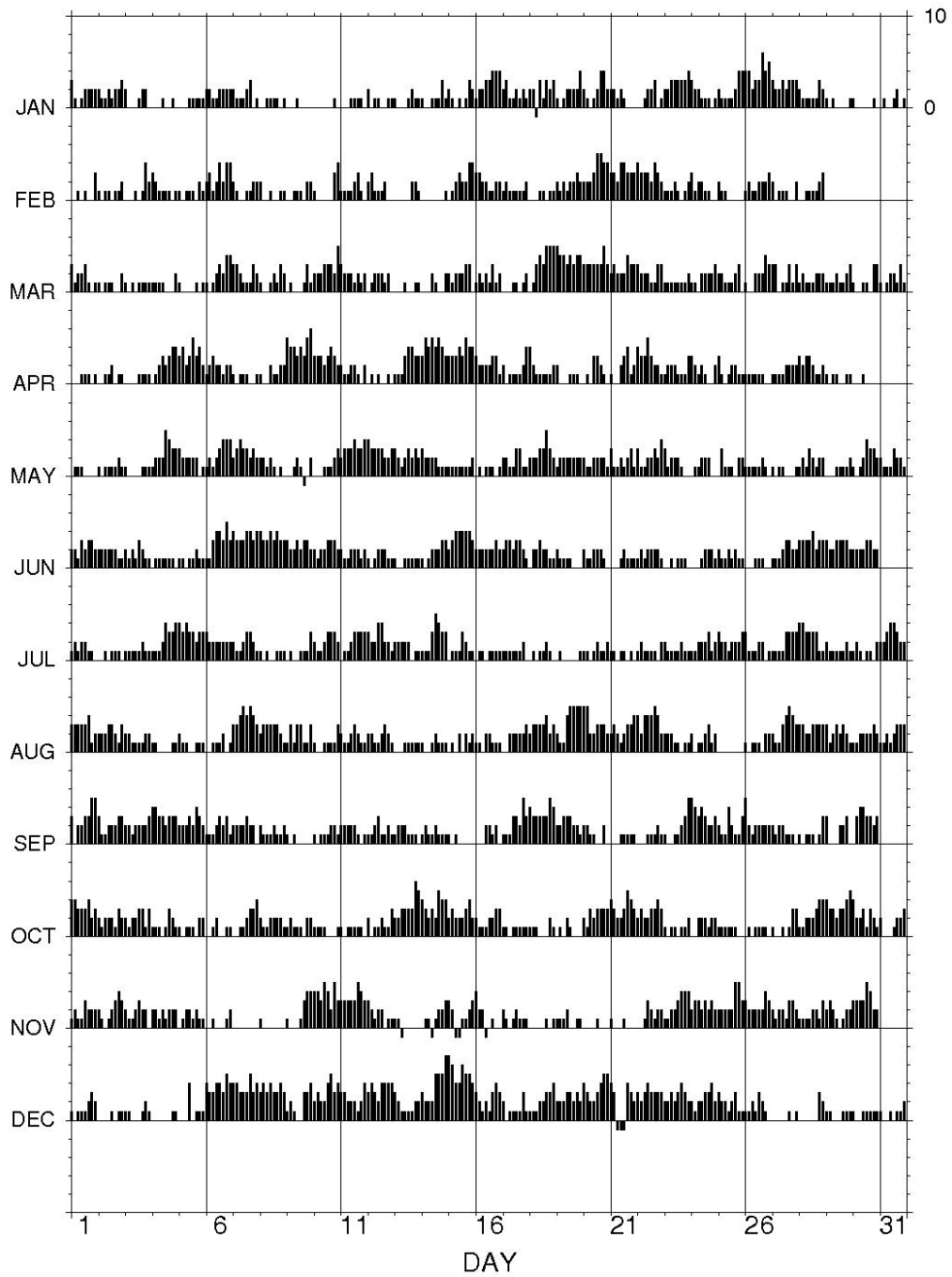

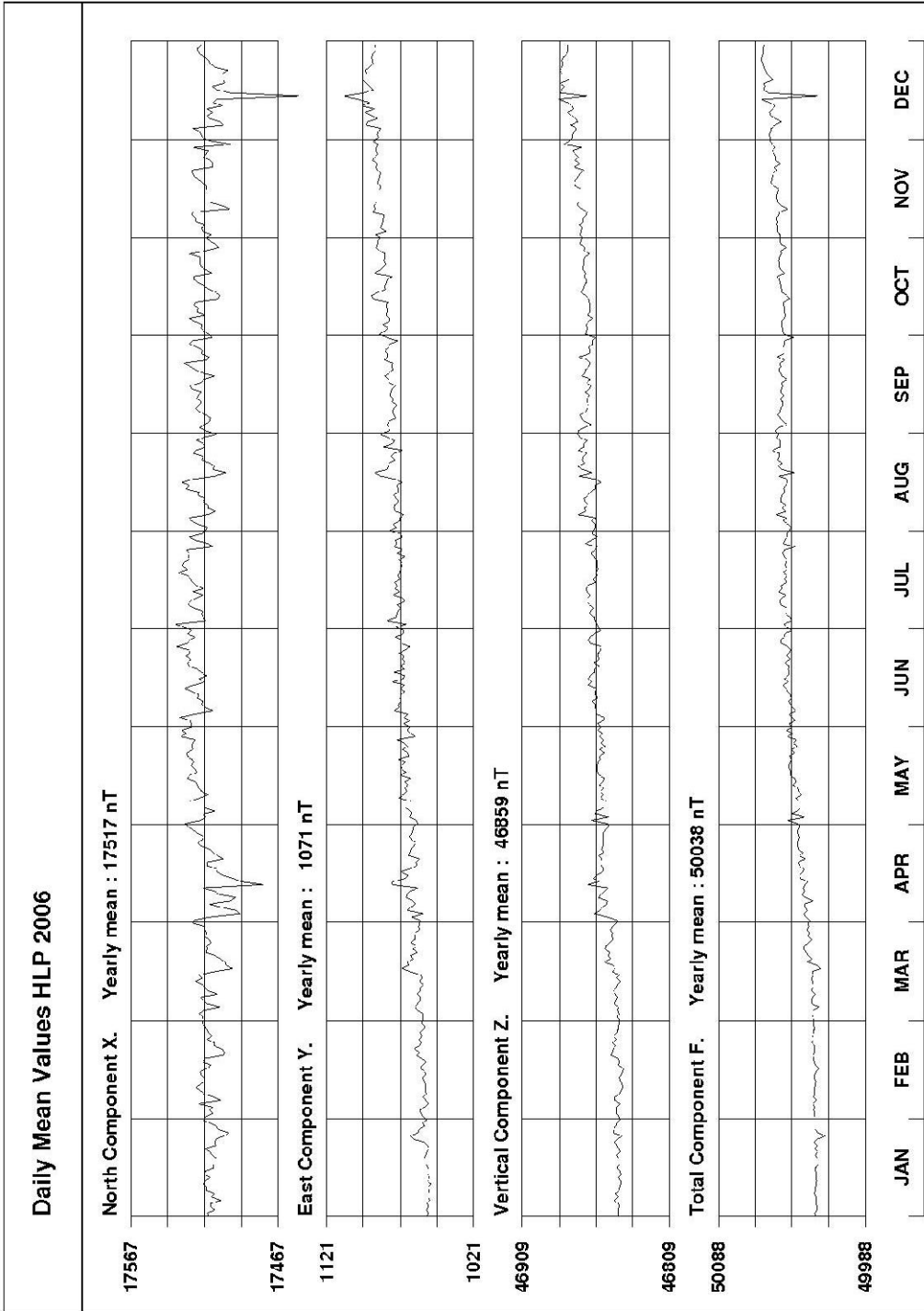

HLP - Hourly Mean Values

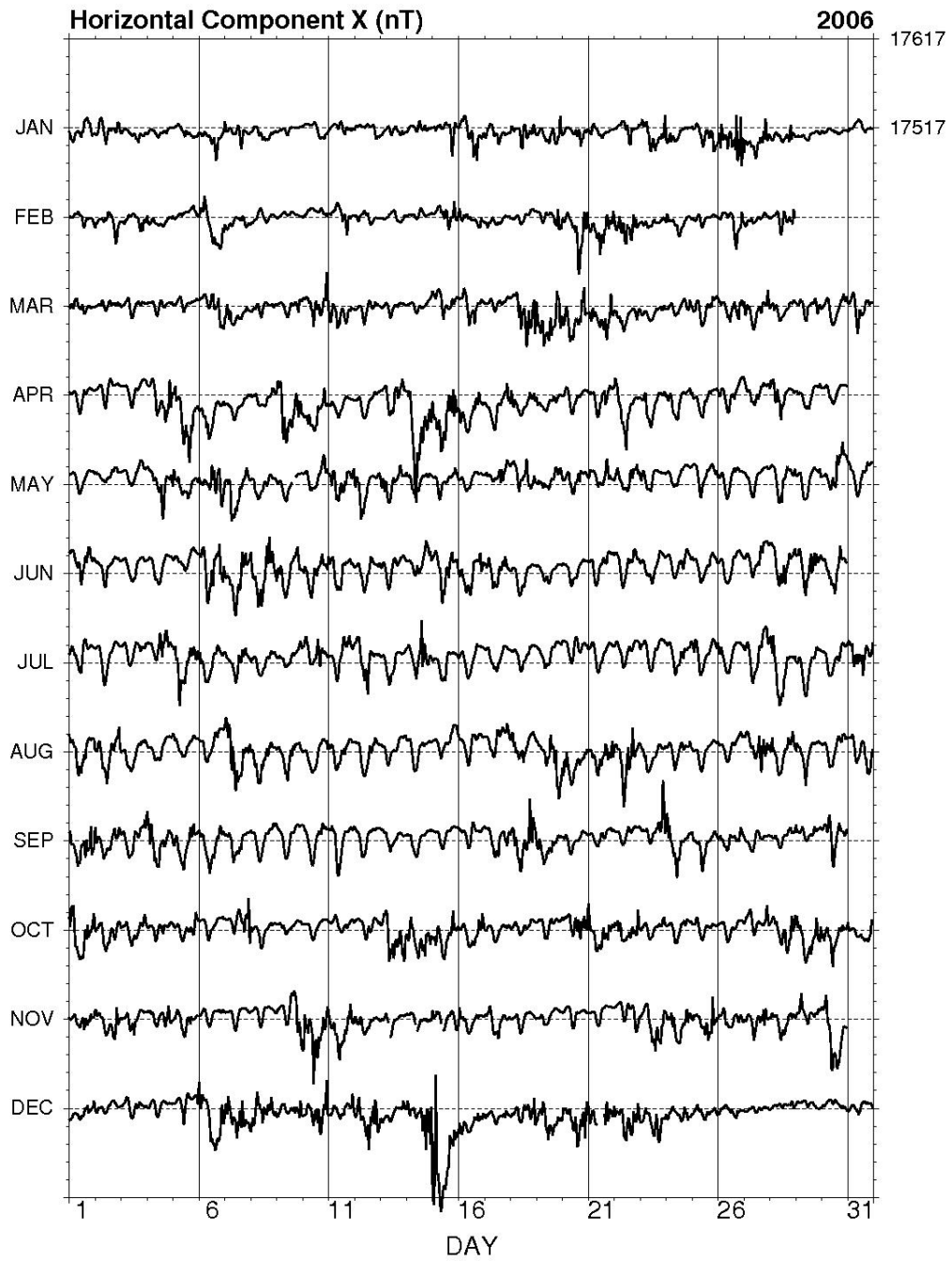

HLP - Hourly Mean Values

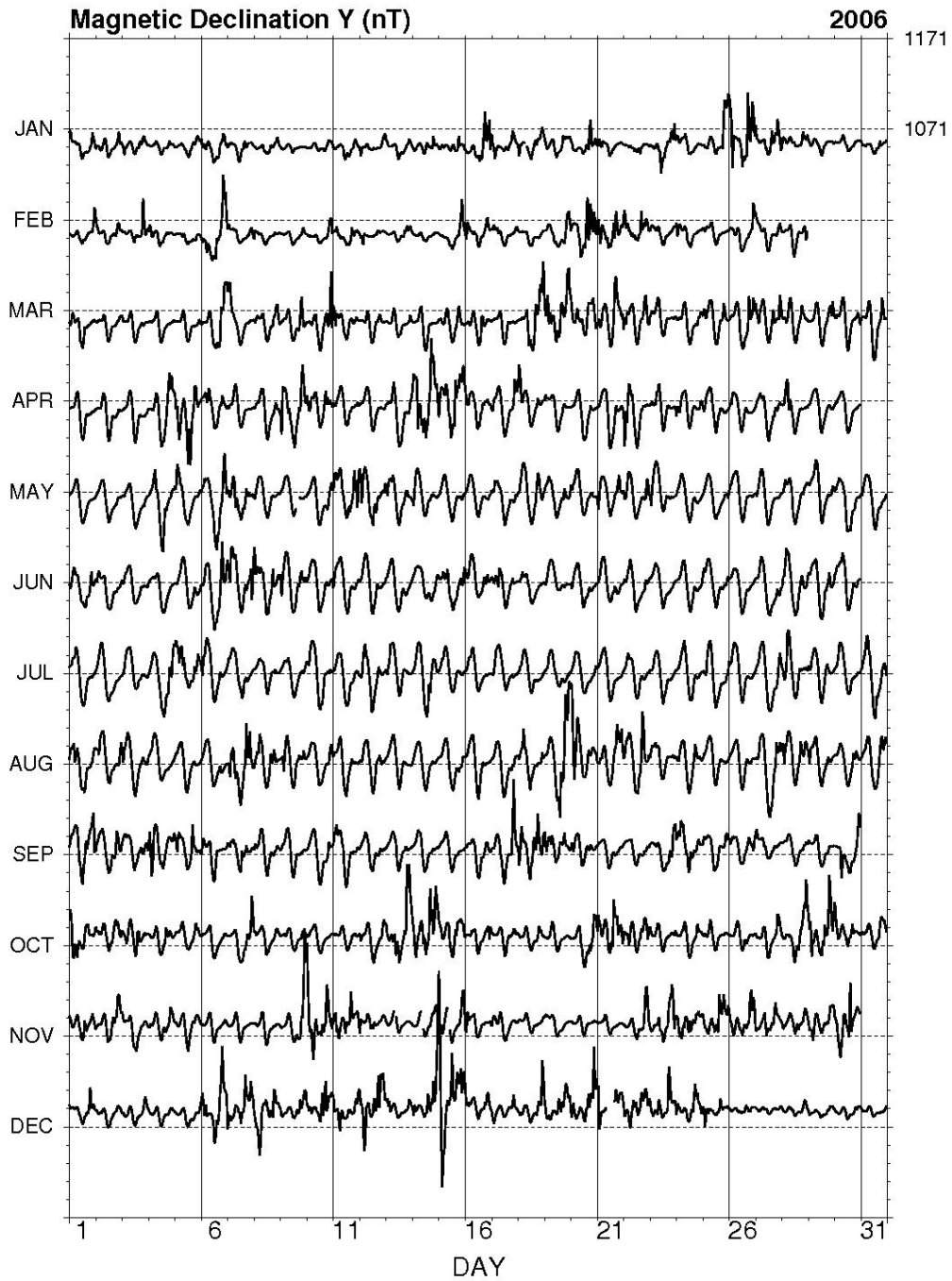

HLP - Hourly Mean Values



TABLES AND PLOTS FOR HORNSUND OBSERVATORY

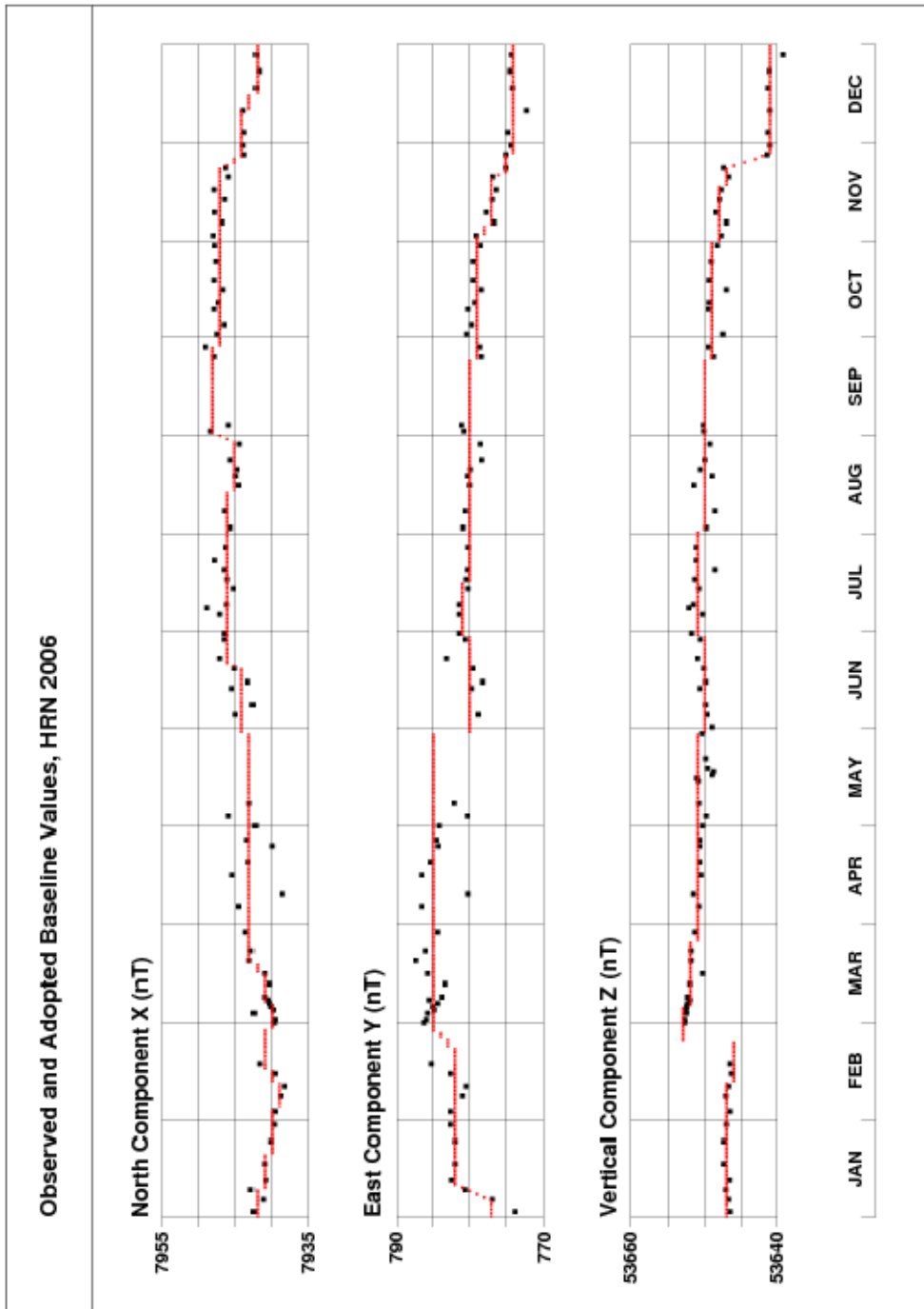

Fig. 13. Base values, Hornsund 2006.

Annual mean values of magnetic elements in Hornsund Observatory

Year	D [° ']	H [nT]	Z [nT]	X [nT]	Y [nT]	I [° ']	F [nT]
1979	-0 32.2	8384	53447	8384	-79	81 05.1	54101
1980	-0 14.2	8370	53447	8370	-35	81 06.0	54098
1981	-0 09.3	8351	53449	8351	-23	81 07.2	54097
1982	-0 09.4	8319	53481	8319	-23	81 09.5	54124
1983	-0 02.0	8295	53457	8295	-5	81 10.8	54097
1984	0 07.7	8266	53439	8266	19	81 12.4	54075
1985	0 14.3	8238	53405	8238	34	81 13.9	54037
1986	0 20.4	8213	53392	8213	49	81 15.3	54020
1987	0 25.6	8193	53360	8193	61	81 16.3	53985
1988	0 34.7	8168	53368	8168	82	81 17.9	53989
1989	0 40.8	8148	53369	8147	97	81 19.2	53987
1990	0 47.2	8122	53360	8121	112	81 20.7	53975
1991	0 53.0	8107	53355	8106	125	81 21.6	53967
1992	1 01.4	8088	53352	8087	144	81 22.8	53962
1993	1 12.9	8065	53356	8063	171	81 24.3	53962
1994	1 25.9	8044	53374	8041	201	81 25.8	53977
1995	1 38.4	8038	53374	8035	230	81 26.1	53976
1996	1 51.4	8023	53385	8019	260	81 27.2	53985
1997	2 07.2	8004	53406	7999	296	81 28.6	54003
1998	2 24.0	8001	53440	7994	335	81 29.1	54036
1999	2 39.1	7998	53471	7989	370	81 29.6	54066
2000	2 55.5	7996	53504	7986	408	81 30.0	54098
2001	3 12.4	7992	53542	7979	447	81 30.6	54135
2002	3 29.7	7989	53585	7974	487	81 31.2	54177
2003	3 49.8	7965	53646	7947	532	81 33.3	54234
2004	4 04.2	7961	53675	7941	565	81 33.8	54262
2005	4 20.5	7953	53707	7930	602	81 34.6	54293
2006	4 36.2	7958	53727	7932	639	81 34.5	54314

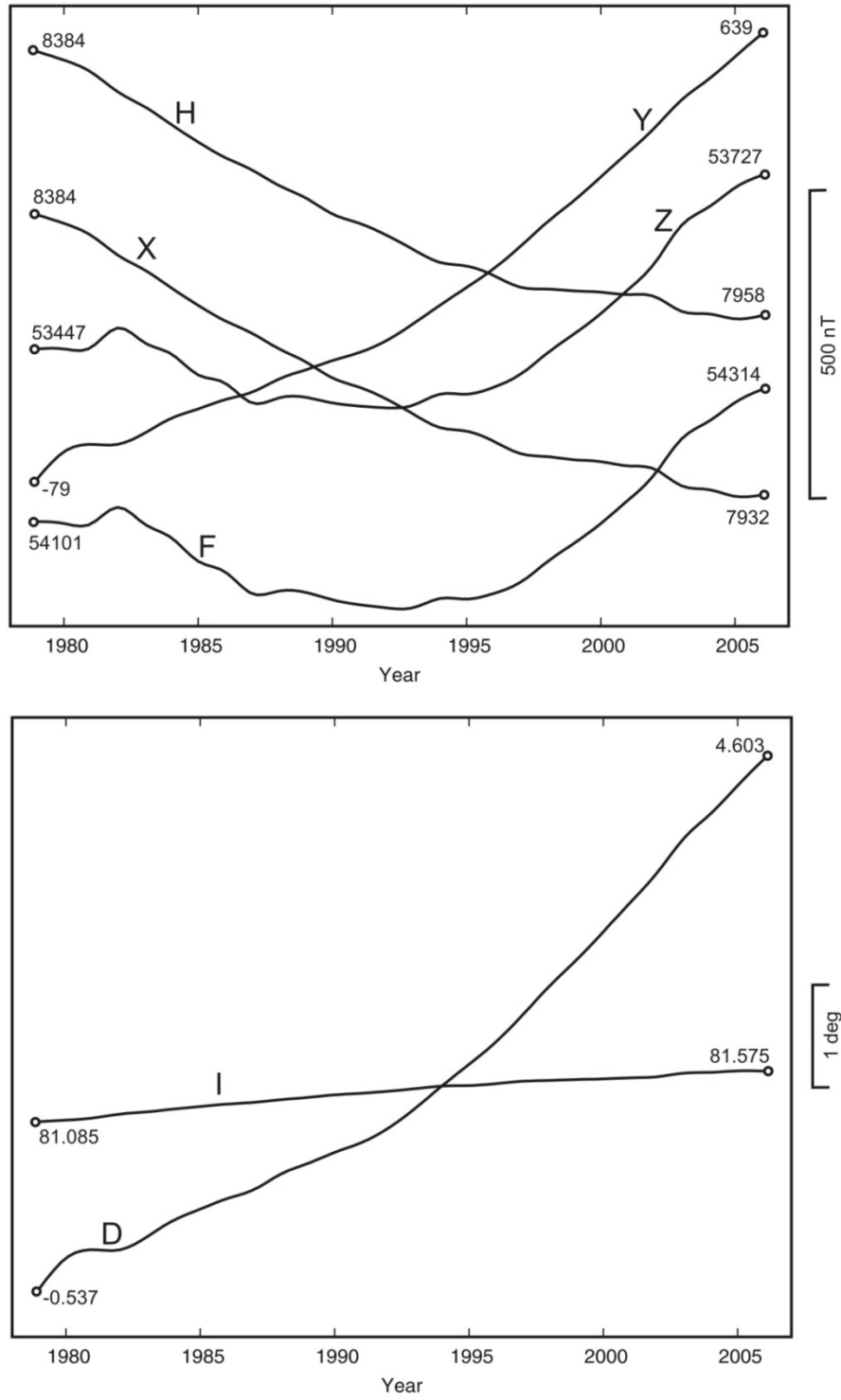

Fig. 14. Secular changes of H, X, Y, Z, F, D and I at Hornsund.

MONTHLY AND YEARLY MEAN VALUES OF MAGNETIC ELEMENTS

HRN

2006

JAN FEB MAR APR MAY JUN JUL AUG SEP OCT NOV DEC MEAN

NORTH COMPONENT: 7500 + ... in nT

All days	425	426	431	435	453	452	446	441	434	426	418	396	432
Quiet days	433	434	436	443	450	445	443	443	438	438	433	428	439
Disturbed days	399	397	402	402	444	458	440	446	428	401	390	333	412

EAST COMPONENT: 500 + ... in nT

All days	124	127	128	137	122	132	137	140	148	150	156	162	139
Quiet days	122	123	128	130	122	132	136	141	146	146	152	151	136
Disturbed days	133	133	131	156	128	132	142	135	154	163	170	179	146

VERTICAL COMPONENT: 53500 + ... in nT

All days	213	211	222	227	218	219	217	223	233	240	246	260	227
Quiet days	206	206	211	212	215	214	219	220	225	223	228	240	218
Disturbed days	223	210	241	256	211	214	213	214	242	272	276	283	238

Three-hour-range indices K
Hornsund, January – March, 2006
The limit of $K = 9$ is 2500 nT

Day	January		February		March	
	K	ΣK	K	ΣK	K	ΣK
1	3123 3232	19	0121 2003	9	3223 3210	16
2	1222 2215	17	3112 1011	10	0222 1002	9
3	1111 1231	11	0111 1041	9	1211 1010	7
4	1111 1040	9	2222 2100	11	0222 1002	9
5	0112 2143	14	1122 3000	9	0101 1001	4
6	2221 3111	13	0542 4224	23	0111 3143	14
7	4322 1214	19	2222 1013	13	3421 2111	15
8	0122 1111	9	2122 0010	8	-1122 2032	-1
9	0112 0000	4	0032 1045	15	1100 1051	9
10	0000 1010	2	1111 0024	10	1222 3226	20
11	0012 1133	11	2222 2210	13	3342 2211	18
12	1221 0011	8	1332 2100	12	0132 2141	14
13	0110 1342	12	0111 1134	12	0221 2001	8
14	0111 2021	8	1120 0000	4	0101 2112	8
15	2112 1011	9	0122 2155	18	2332 2250	19
16	1133 2354	22	4442 2242	24	0222 1312	13
17	4333 3232	23	0322 2111	12	0121 1011	7
18	2333 1254	23	0101 1000	3	0234 3535	25
19	1233 2345	23	1333 1154	21	5454 3265	34
20	2212 1240	14	1334 4355	28	3444 2364	30
21	1222 2100	10	4334 5652	32	2543 3325	27
22	0122 3300	11	4444 3254	30	3333 2254	25
23	0244 3115	20	233-1 -1-1-1-1	-1	1333 2102	15
24	4343 3000	17	-1-1-1-1 -1100	-1	1212 3113	14
25	0111 2244	15	122-1 -1000	-1	2232 1051	16
26	5333 3757	36	0222 2314	16	0212 2224	15
27	4444 3365	33	3221 2002	12	3321 3315	21
28	3332 2152	21	1112 2113	12	1322 2141	16
29	1221 0001	7			1321 2133	16
30	1101 1020	6			1111 1022	9
31	0210 1101	6			1222 2241	16

Three-hour-range indices K
Hornsund, April – June, 2006
The limit of K = 9 is 2500 nT

Day	April		May		June	
	K	ΣK	K	ΣK	K	ΣK
1	0121 1000	5	0322 0100	8	3334 3234	25
2	0010 3000	4	1120 1131	10	2333 2212	18
3	0000 1101	3	0110 0012	5	2232 3211	16
4	1122 2223	15	1234 4421	21	1221 2101	10
5	4223 4322	22	4332 2210	17	1212 1232	14
6	1223 2233	18	2223 4535	26	2445 4333	28
7	1212 1100	8	2455 4222	26	3445 3344	30
8	1112 2122	12	2343 2111	17	4353 4535	32
9	4334 4255	30	1232 2221	15	3333 2253	24
10	3344 3232	24	0101 1112	7	3333 3442	25
11	2322 2211	15	2434 4344	28	4322 2213	19
12	1131 1120	10	4443 4335	30	2122 2212	14
13	1223 3314	19	3433 3251	24	3111 2112	12
14	5434 3544	32	3442 2231	21	2122 3224	18
15	3445 4654	35	1222 2212	14	3455 5344	33
16	3443 3443	28	2111 1110	8	3333 2354	26
17	2332 2215	20	1322 3221	16	3454 3232	26
18	5322 1143	21	1244 3432	23	1254 3231	21
19	2211 1210	10	3322 3343	23	3231 1111	13
20	0113 2220	11	2333 2233	21	2322 2101	13
21	0112 2221	11	3223 2143	20	1011 1121	8
22	4345 4211	24	2223 3234	21	2322 2221	16
23	2333 2102	16	3342 2221	19	0020 1110	5
24	2333 1112	16	1323 2210	14	1112 2111	10
25	2222 2211	14	1322 1013	13	3212 1102	12
26	1321 2200	11	3211 2231	15	1002 2011	7
27	1221 2231	14	1231 1111	11	1122 3223	16
28	2244 2111	17	2323 3112	17	3354 4343	29
29	1121 1021	9	2111 1111	9	3433 3342	25
30	1011 0000	3	2212 3243	19	4443 3521	26
31			2232 2112	15		

Three-hour-range indices K
Hornsund, July – September, 2006
The limit of K = 9 is 2500 nT

Day	July		August		September	
	K	ΣK	K	ΣK	K	ΣK
1	2332 2121	16	2443 3314	24	4223 3323	22
2	0021 1121	8	3434 3234	26	3322 2233	20
3	0121 2211	10	3332 2132	19	3322 3223	20
4	1223 4244	22	2111 0021	8	3533 2353	27
5	4453 3253	29	2311 1220	12	3434 2542	27
6	3333 2143	22	1132 2210	12	2233 3253	23
7	3223 3322	20	3456 5633	35	2333 3321	20
8	2221 0112	11	3343 4441	26	1222 1111	11
9	2211 1133	14	3433 3334	26	1110 1000	4
10	3222 3231	18	1111 2115	13	1141 1111	11
11	1112 2222	13	2232 3211	16	2334 2101	16
12	3345 4232	26	2322 3321	18	1123 1010	9
13	2333 3110	16	1011 1011	6	0232 1110	10
14	1223 5522	22	1111 3111	10	0222 3110	11
15	1333 3232	20	0102 1112	8	1020 1000	4
16	1221 1221	12	2211 2000	8	0101 2120	7
17	1222 2111	12	0122 3113	13	1224 4142	20
18	1202 2110	9	2233 2213	18	5433 4374	33
19	1100 0001	3	2214 6534	27	2443 4311	22
20	1211 2112	11	4432 3333	25	1331 1030	12
21	2110 0011	6	3333 3345	27	0122 2101	9
22	1221 0111	9	4344 3641	29	0002 0110	4
23	1111 1100	6	2331 2022	15	1121 1125	14
24	1222 3312	16	2322 3332	20	3444 4222	25
25	2431 2112	16	1111 1010	6	3234 3114	21
26	3212 2100	11	1002 2112	9	3333 2132	20
27	1121 3224	16	1324 4322	21	2322 1110	12
28	6654 2211	27	3443 3535	30	1212 2002	10
29	1212 1121	11	3333 2241	21	2010 1021	7
30	2231 1111	12	1233 2233	19	0344 2114	19
31	2434 4233	25	1123 3322	17		

Three-hour-range indices K
Hornsund, October – December, 2006
The limit of K = 9 is 2500 nT

Day	October		November		December	
	K	ΣK	K	ΣK	K	ΣK
1	4443 3534	30	2321 3223	18	0123 2232	15
2	3323 2333	22	2221 2444	21	0111 1011	6
3	2332 4312	20	2222 3111	14	1220 0113	10
4	1231 2521	17	1222 2144	18	1210 0011	6
5	1212 2122	13	1233 2121	15	0001 0101	3
6	0122 0001	6	1201 1012	8	4333 3335	27
7	0221 2336	19	0201 0000	3	4534 4655	36
8	2222 2211	14	1000 0000	1	4555 5474	39
9	0222 1033	13	1010 1126	12	2332 2545	26
10	2221 1000	8	4333 3262	26	3543 34-16	-1
11	0211 1110	7	4333 3355	29	3354 2126	26
12	1221 2102	11	4432 2143	23	3543 4666	37
13	1223 2262	20	2320 0000	7	4333 2225	24
14	2533 2645	30	0322 2222	15	4434 6668	41
15	3433 2563	29	3322 1113	16	7733 5656	42
16	2222 2245	21	4321 0000	10	5343 3154	28
17	1221 1032	12	3322 2221	17	2222 1152	17
18	0111 0053	11	0000 0313	7	2323 2225	21
19	0211 1110	7	5323 1113	19	2234 3254	25
20	1132 3214	17	0100 1001	3	4443 3365	32
21	4443 3643	31	1000 1000	2	4443 3654	33
22	3433 2245	26	0011 1034	10	3343 2354	27
23	2123 1002	11	0243 3334	22	2334 3652	28
24	1233 2141	17	3332 2164	24	4343 2653	30
25	1223 3110	13	2343 2564	29	3333 3211	19
26	1323 1210	13	3443 3235	27	1341 3220	16
27	1111 0034	11	2334 1163	23	0111 1101	6
28	1223 2335	21	2222 3325	21	1000 0054	10
29	4334 2375	31	2432 0233	19	1110 0041	8
30	3432 3441	24	3323 4311	20	1111 0033	10
31	4112 2243	19			0010 0012	4

HRN

K-Indices

2006

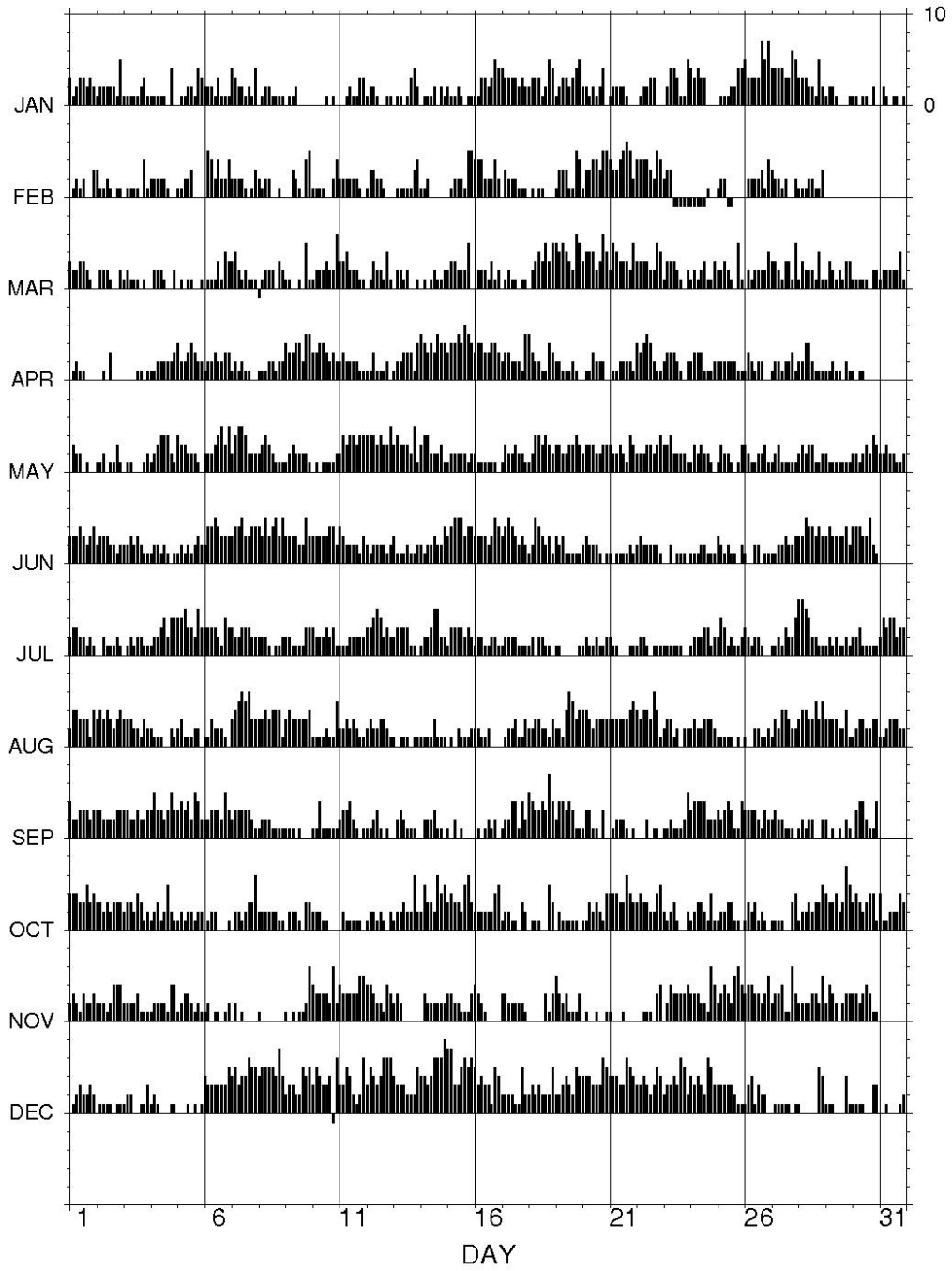

HRN - Hourly Mean Values

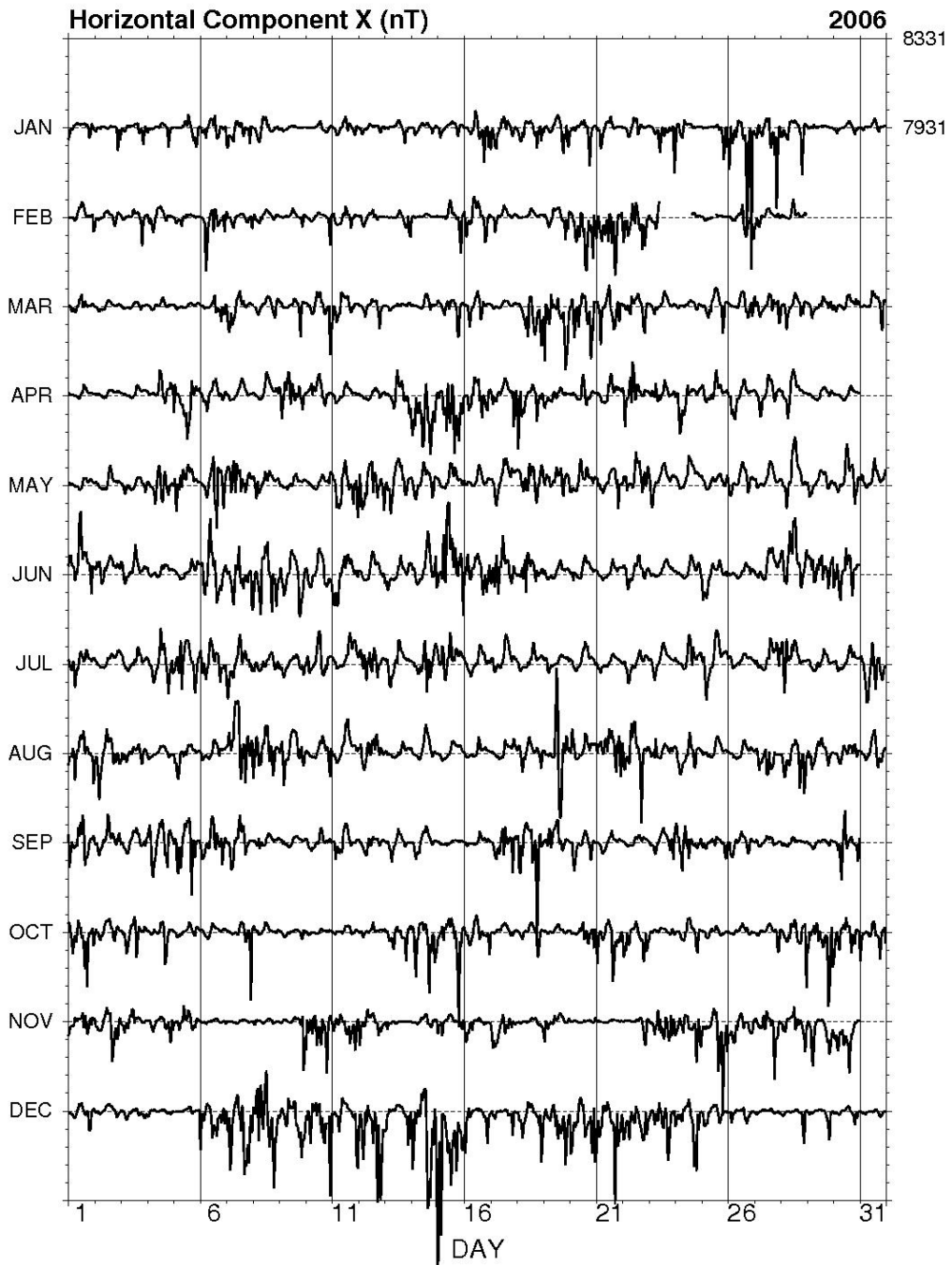

HRN - Hourly Mean Values

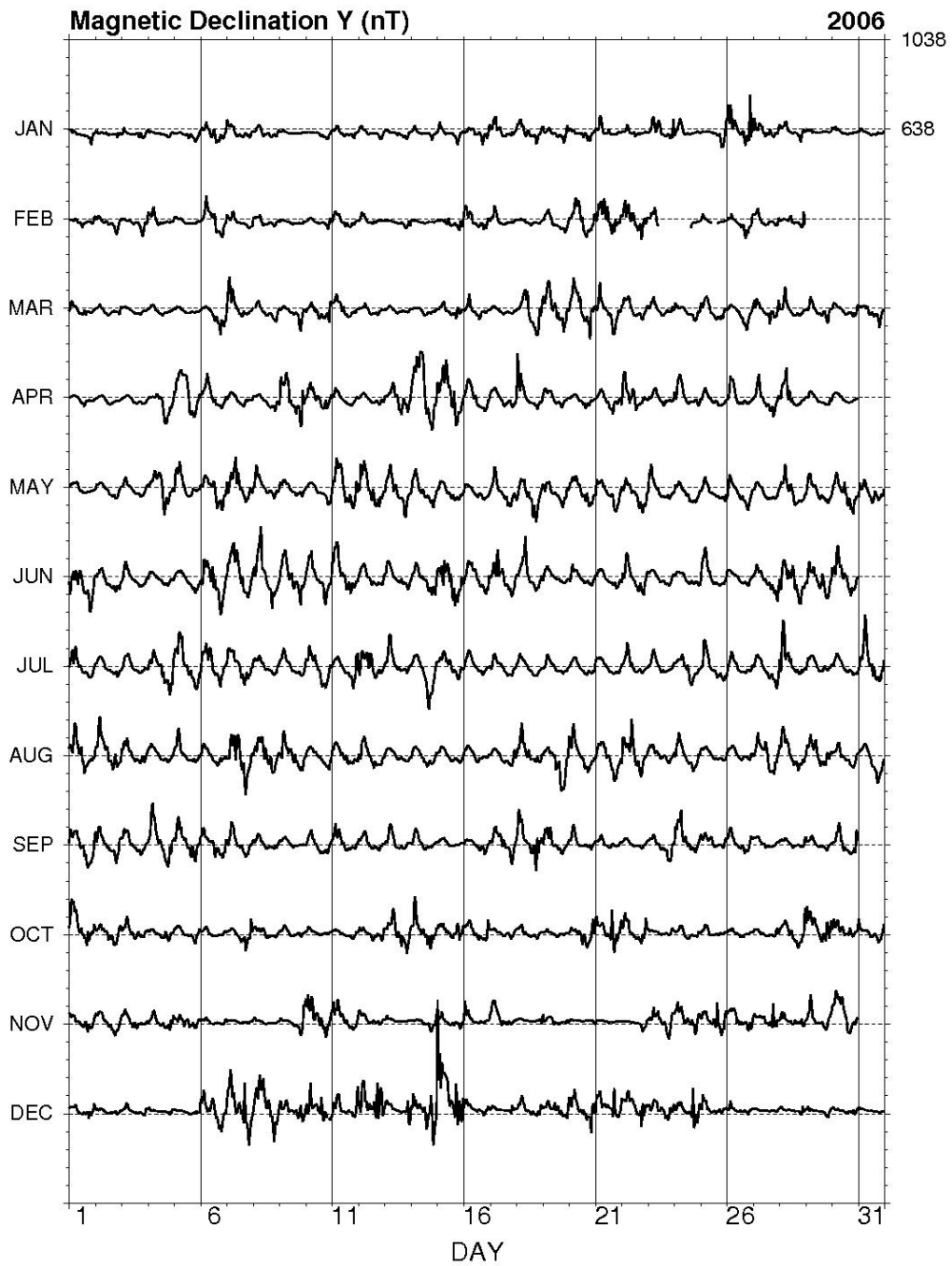

HRN - Hourly Mean Values

